

dół przód

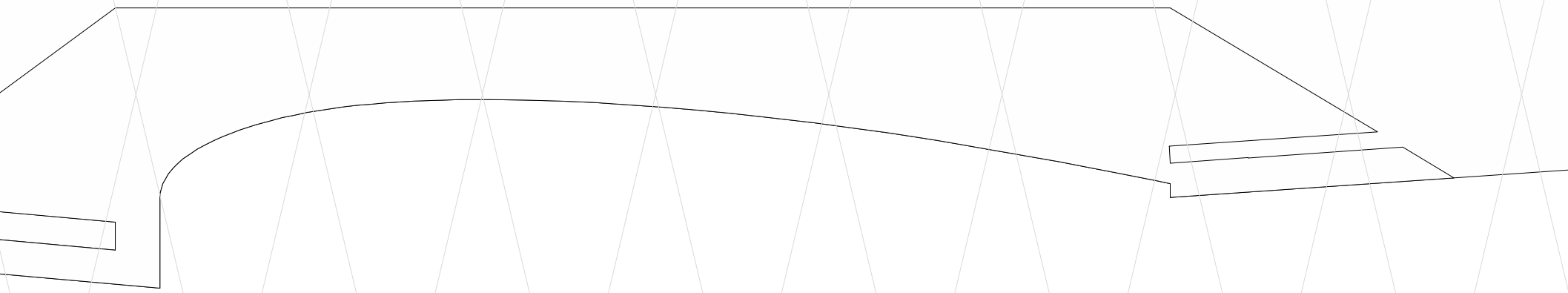

dół tył

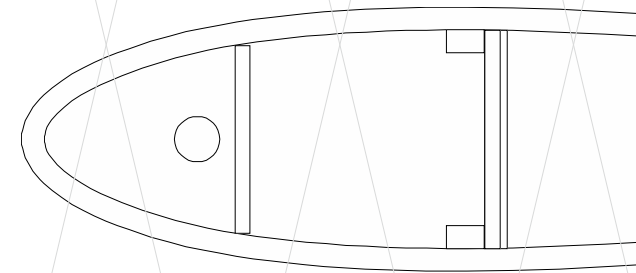

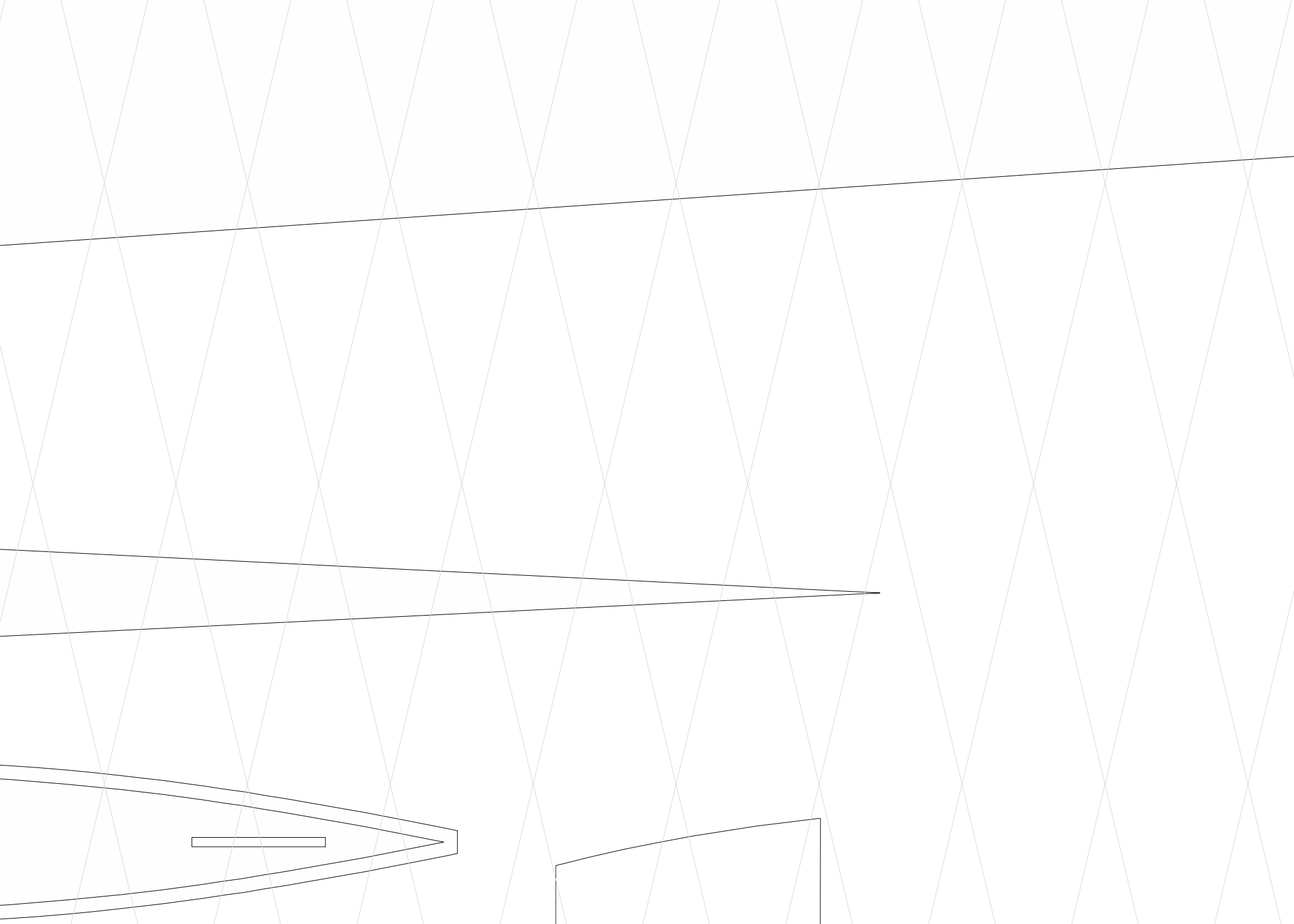

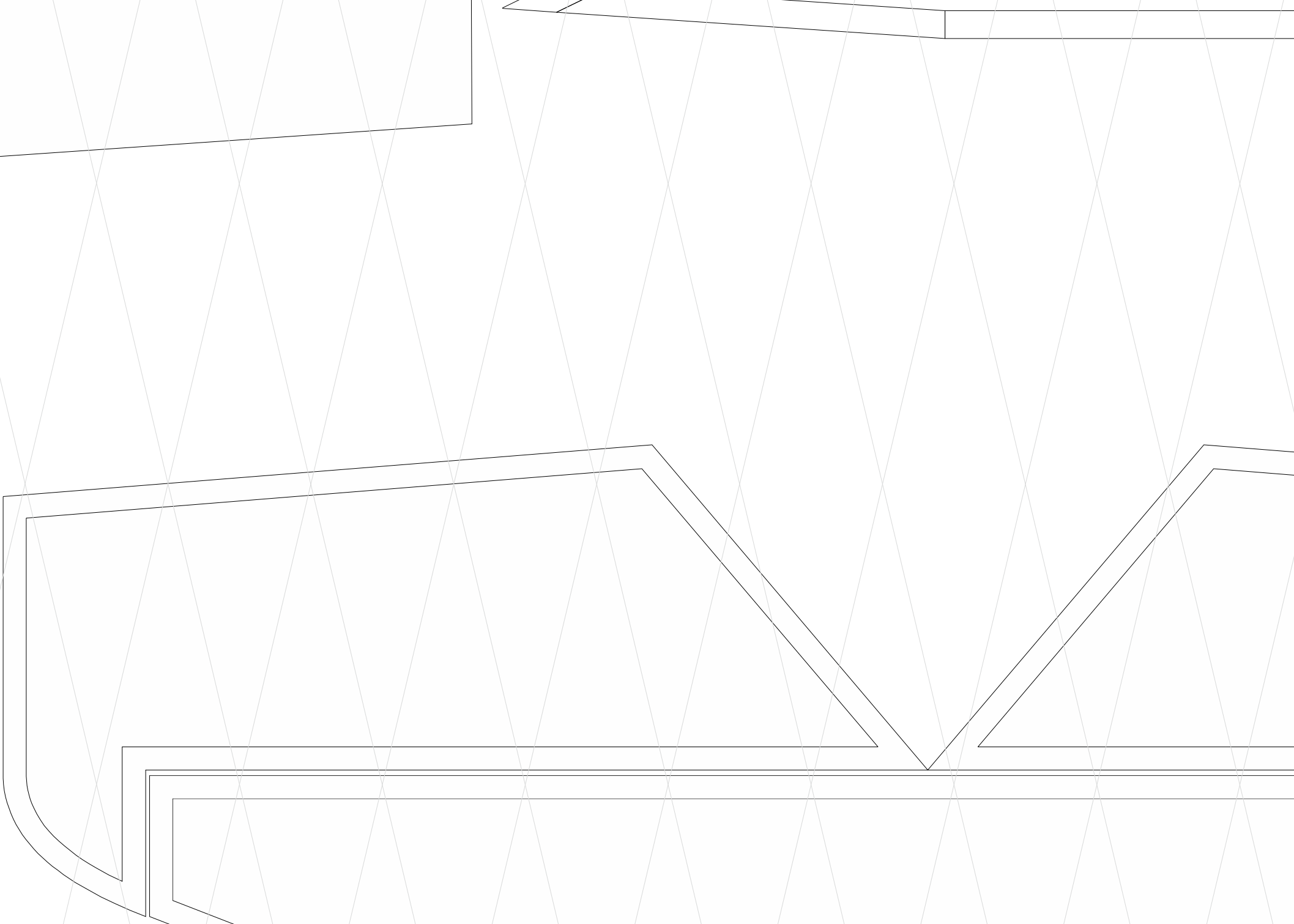

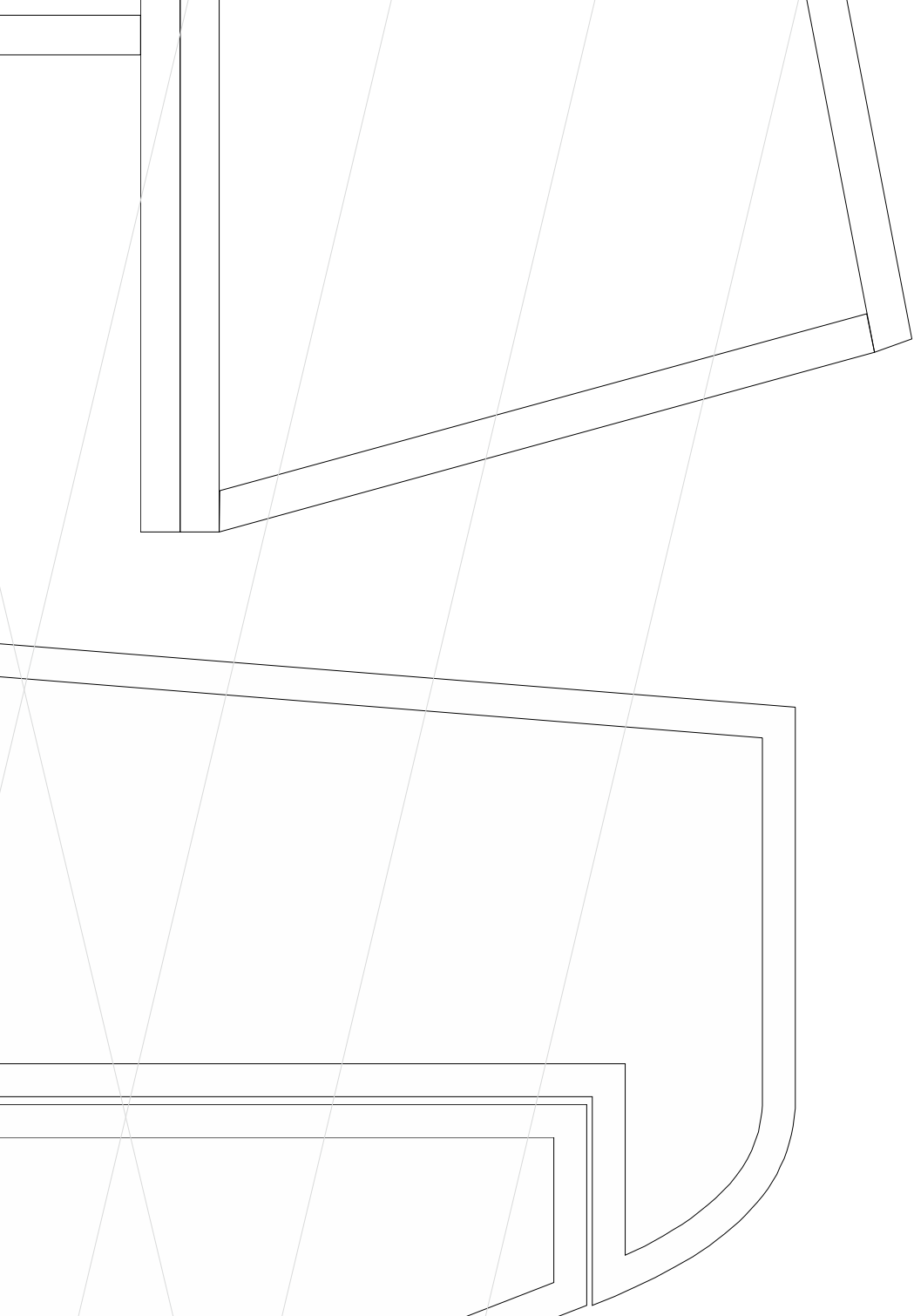

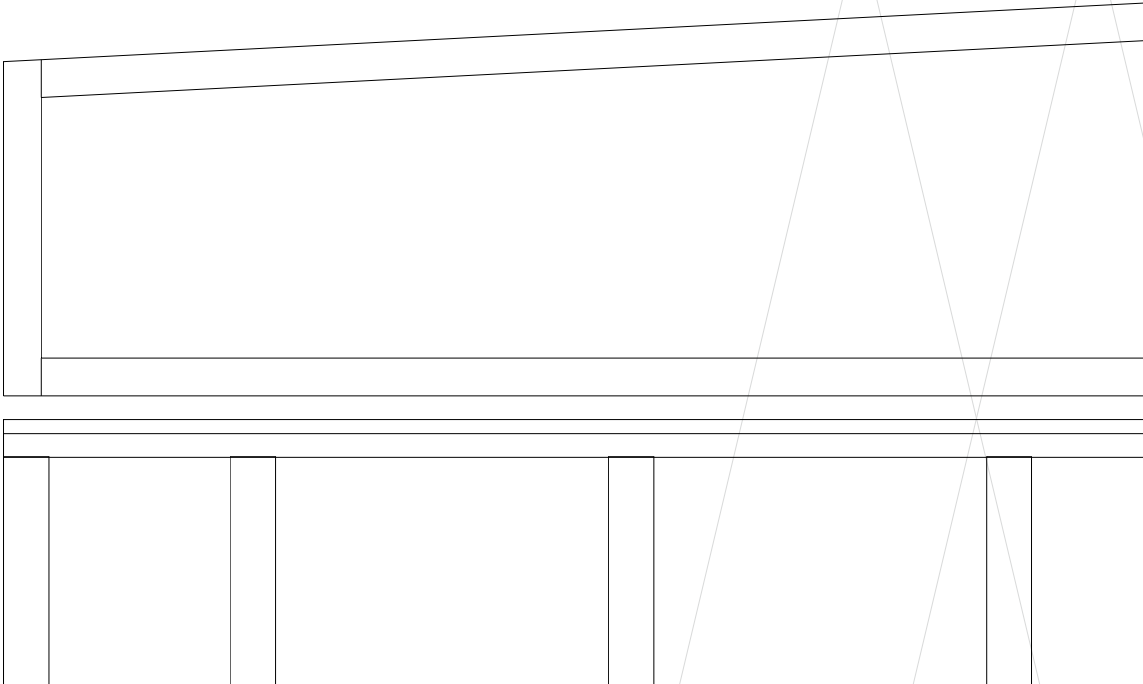
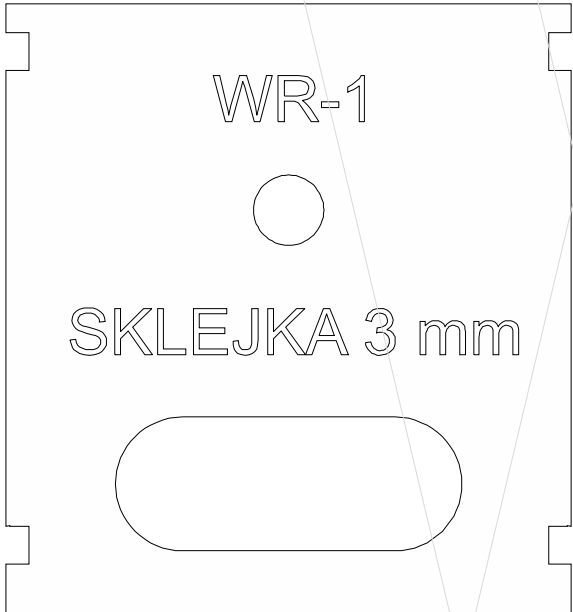

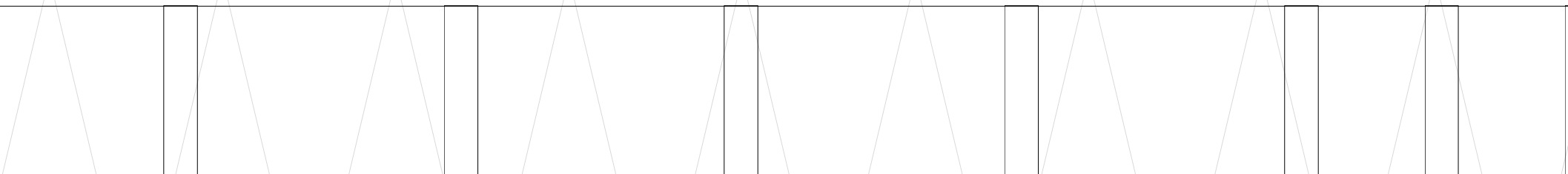
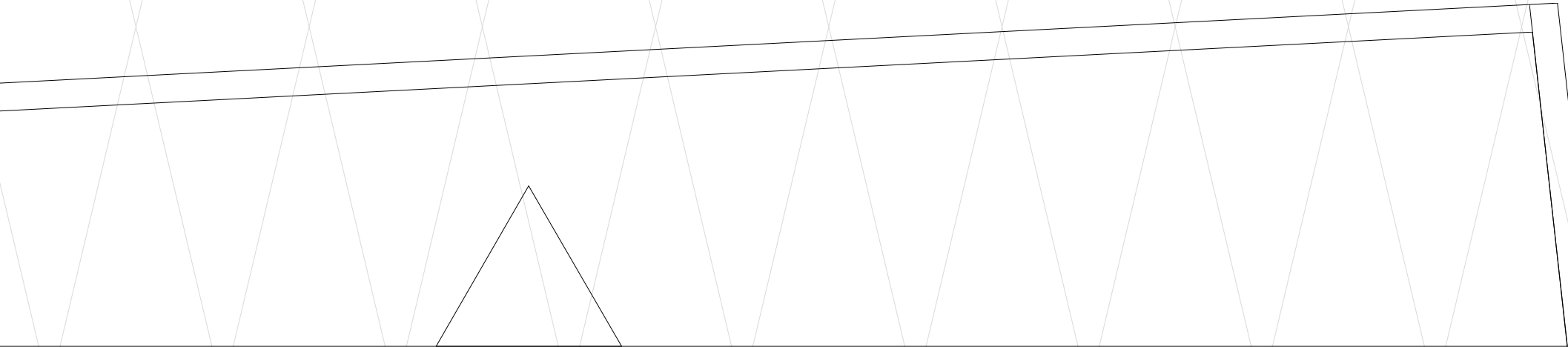
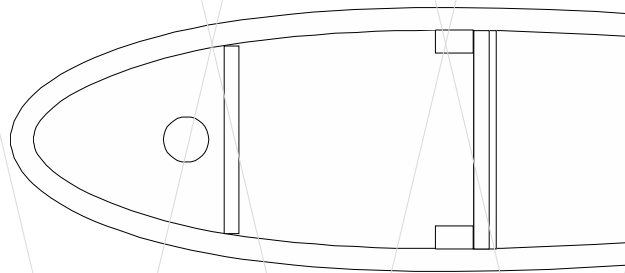
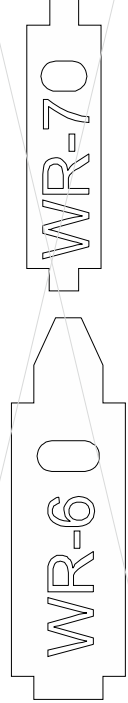
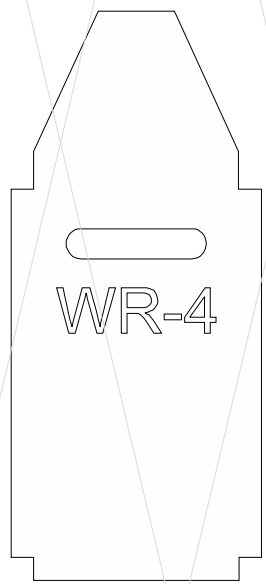
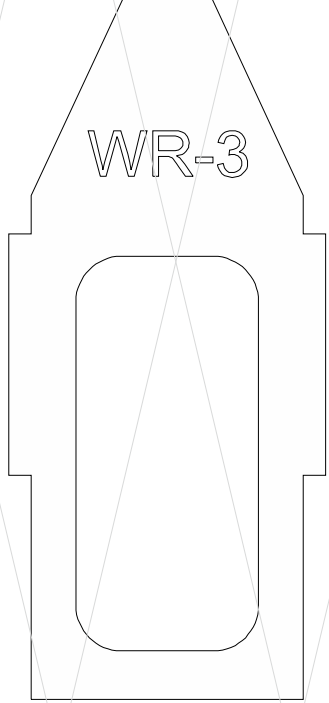
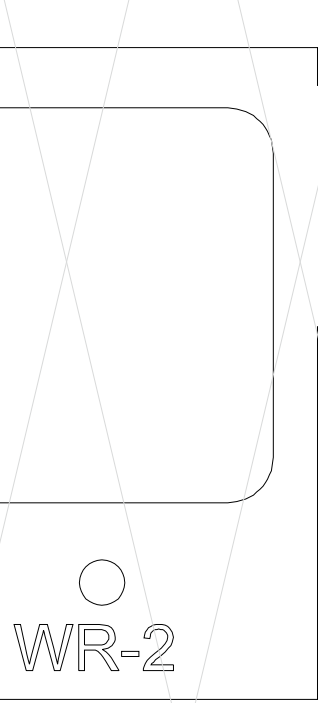

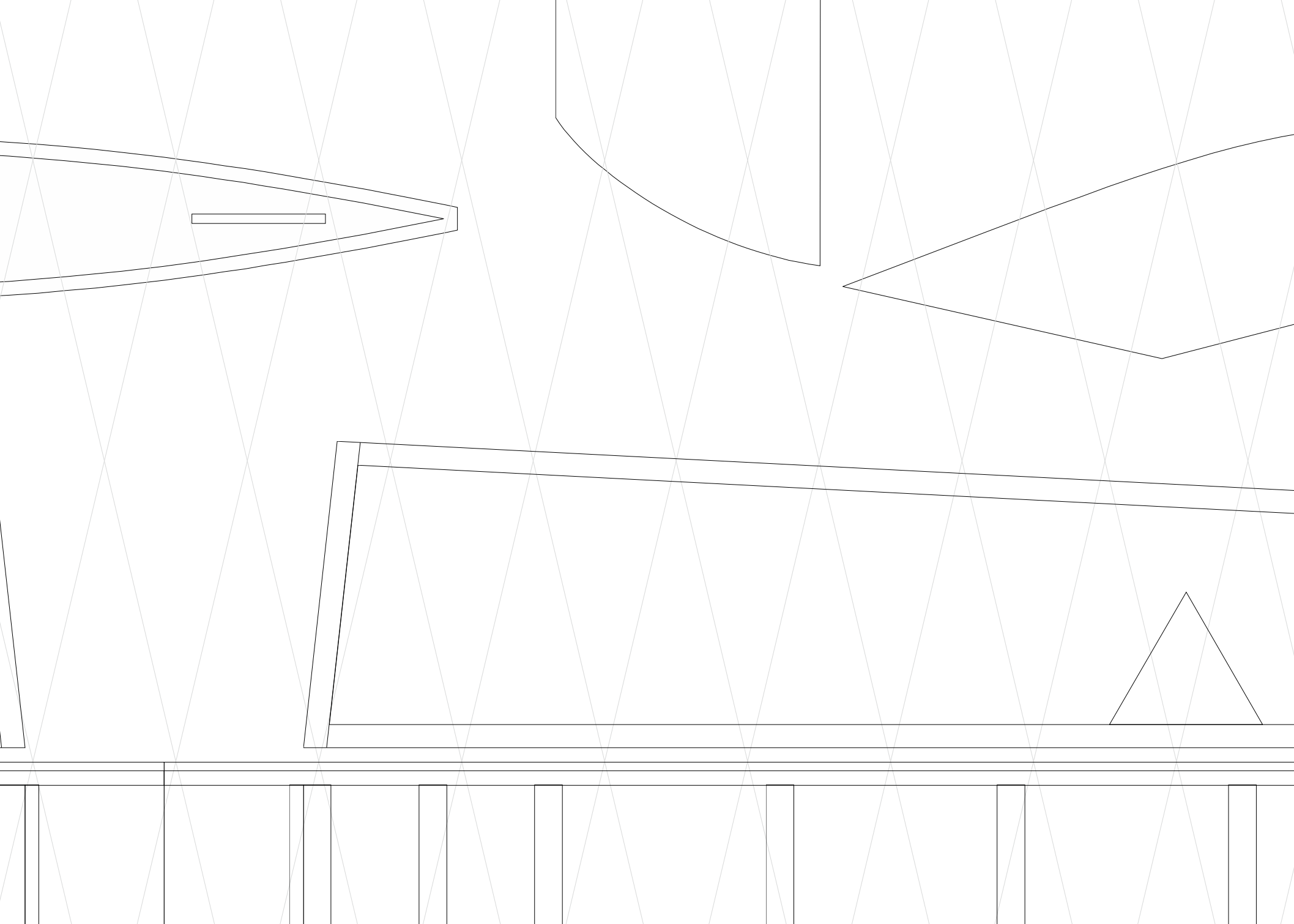

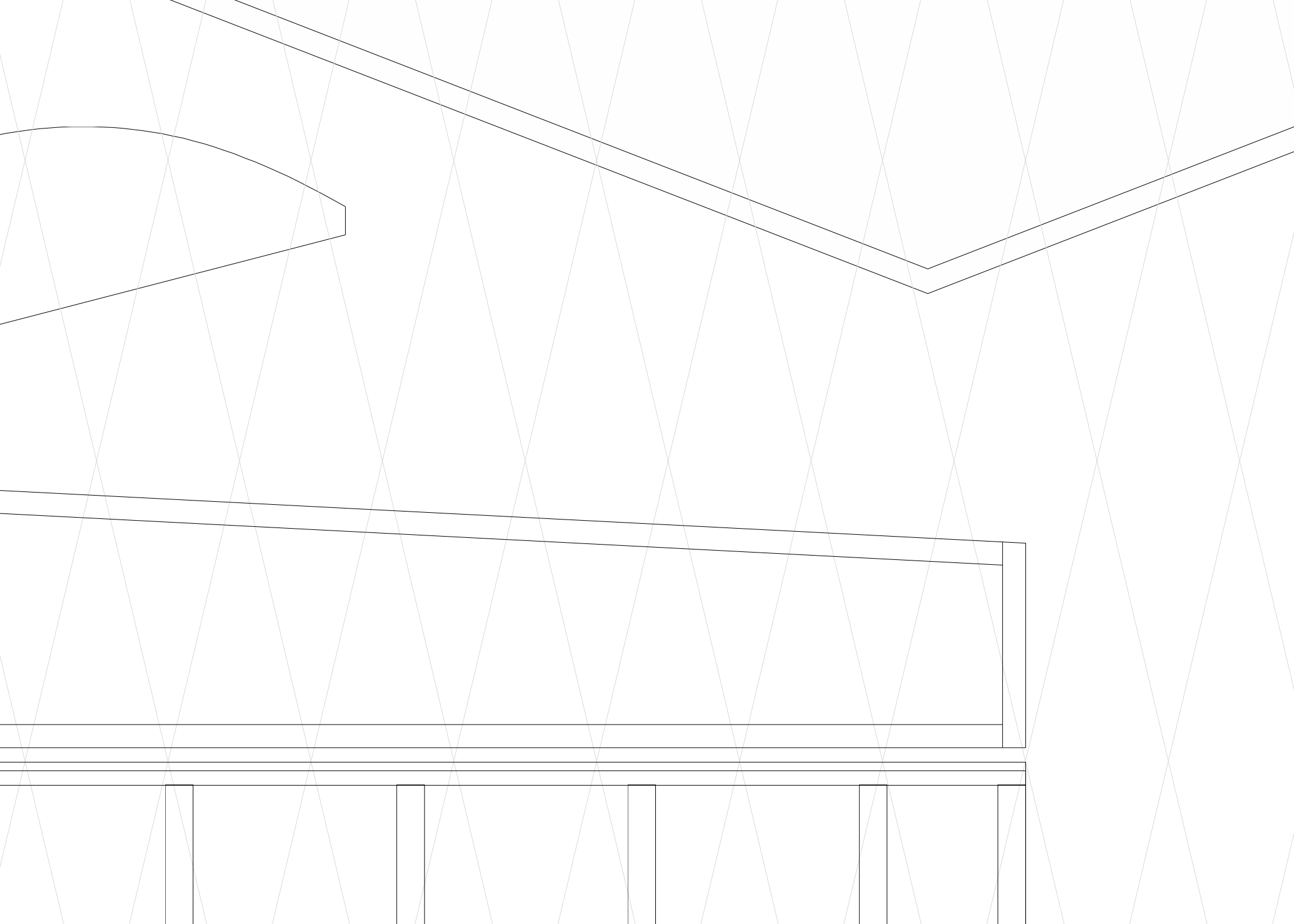

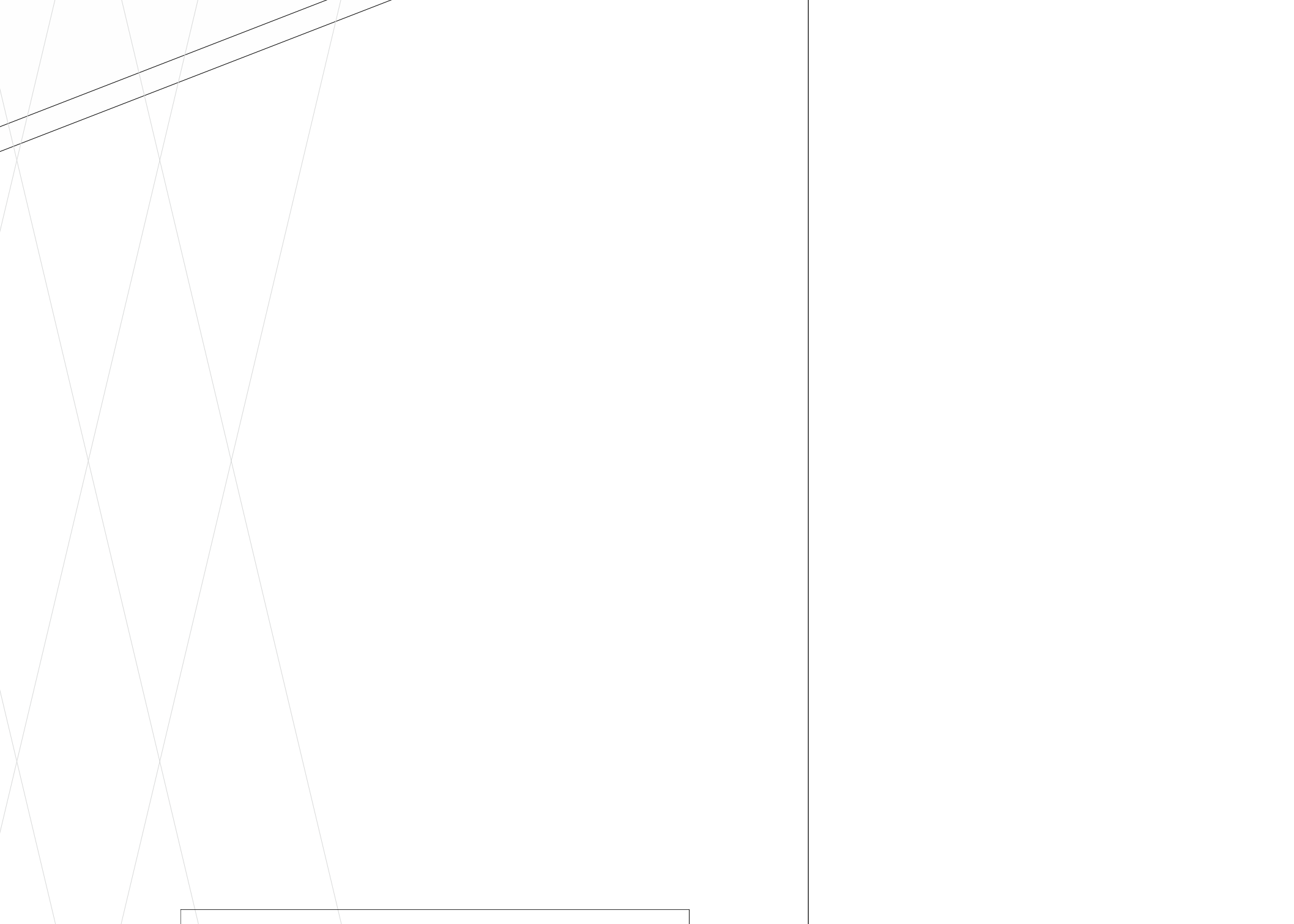

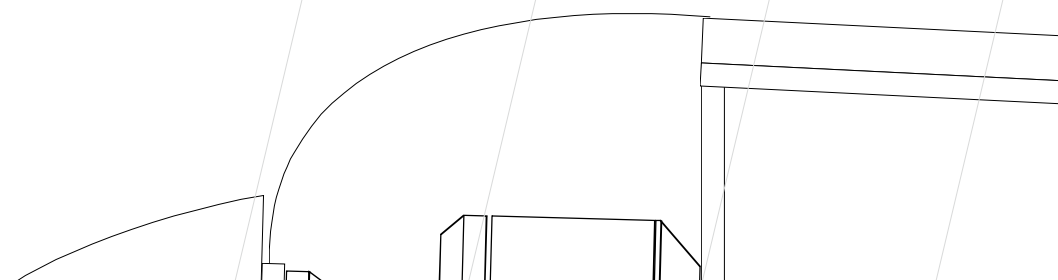
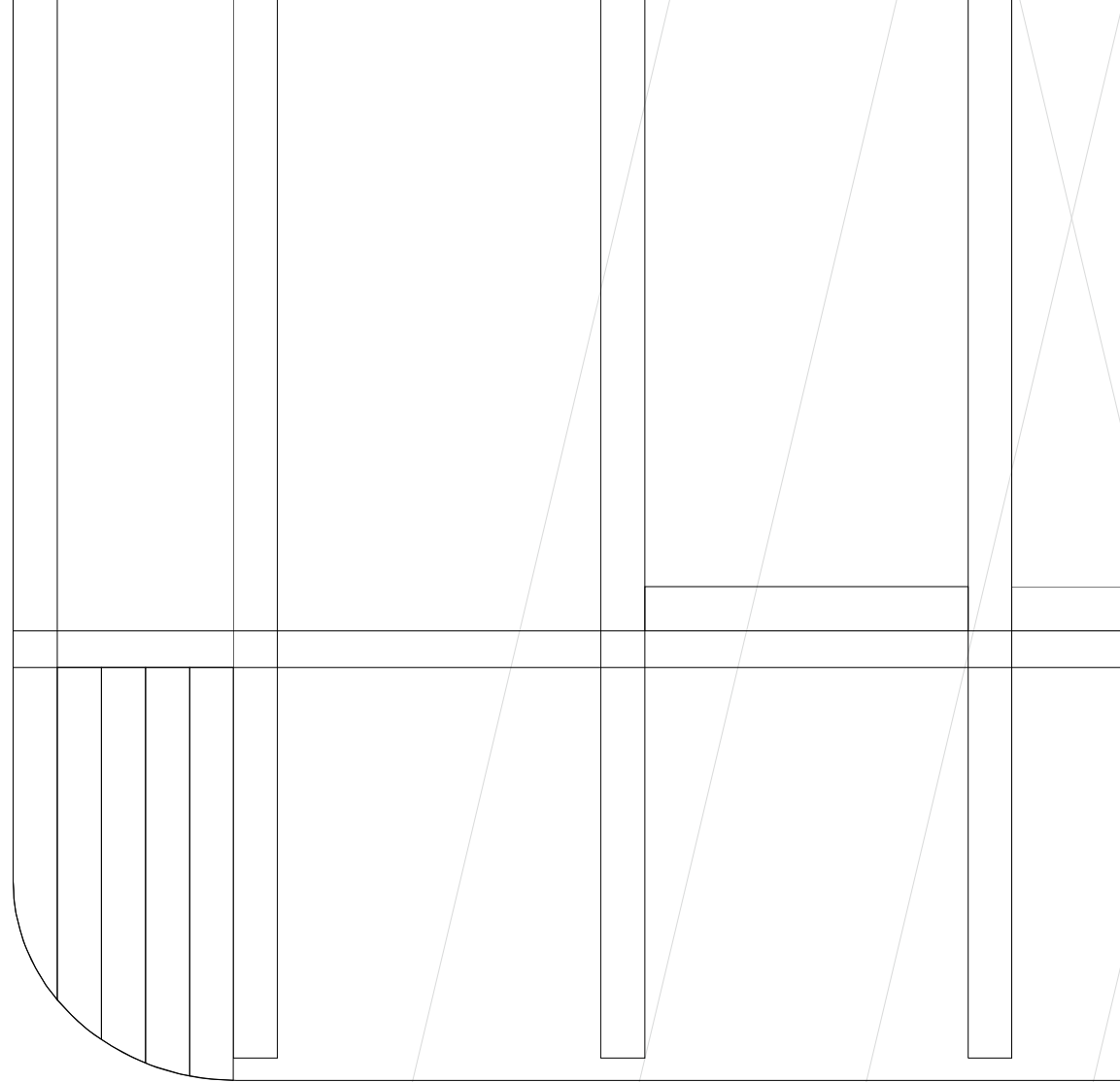

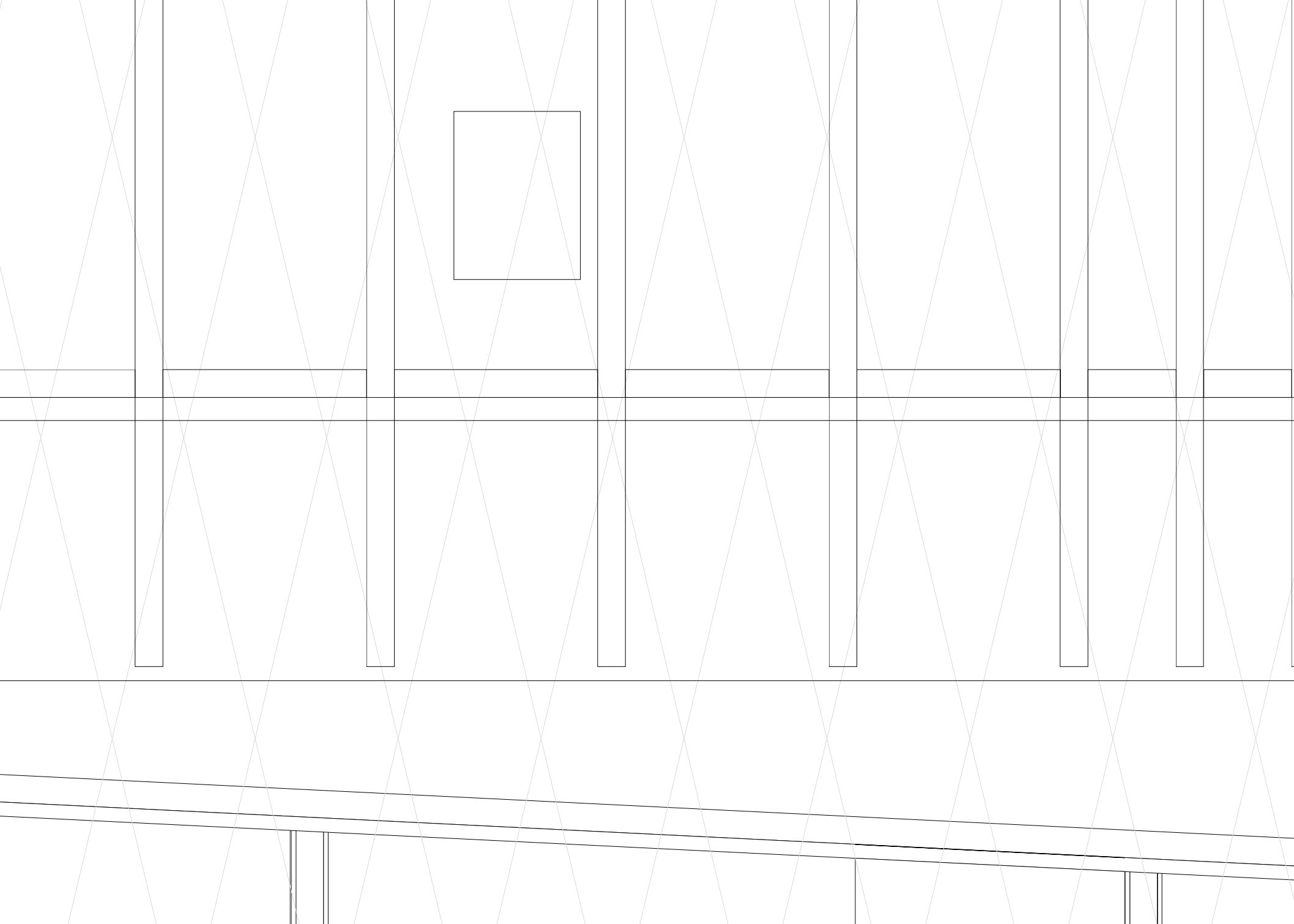

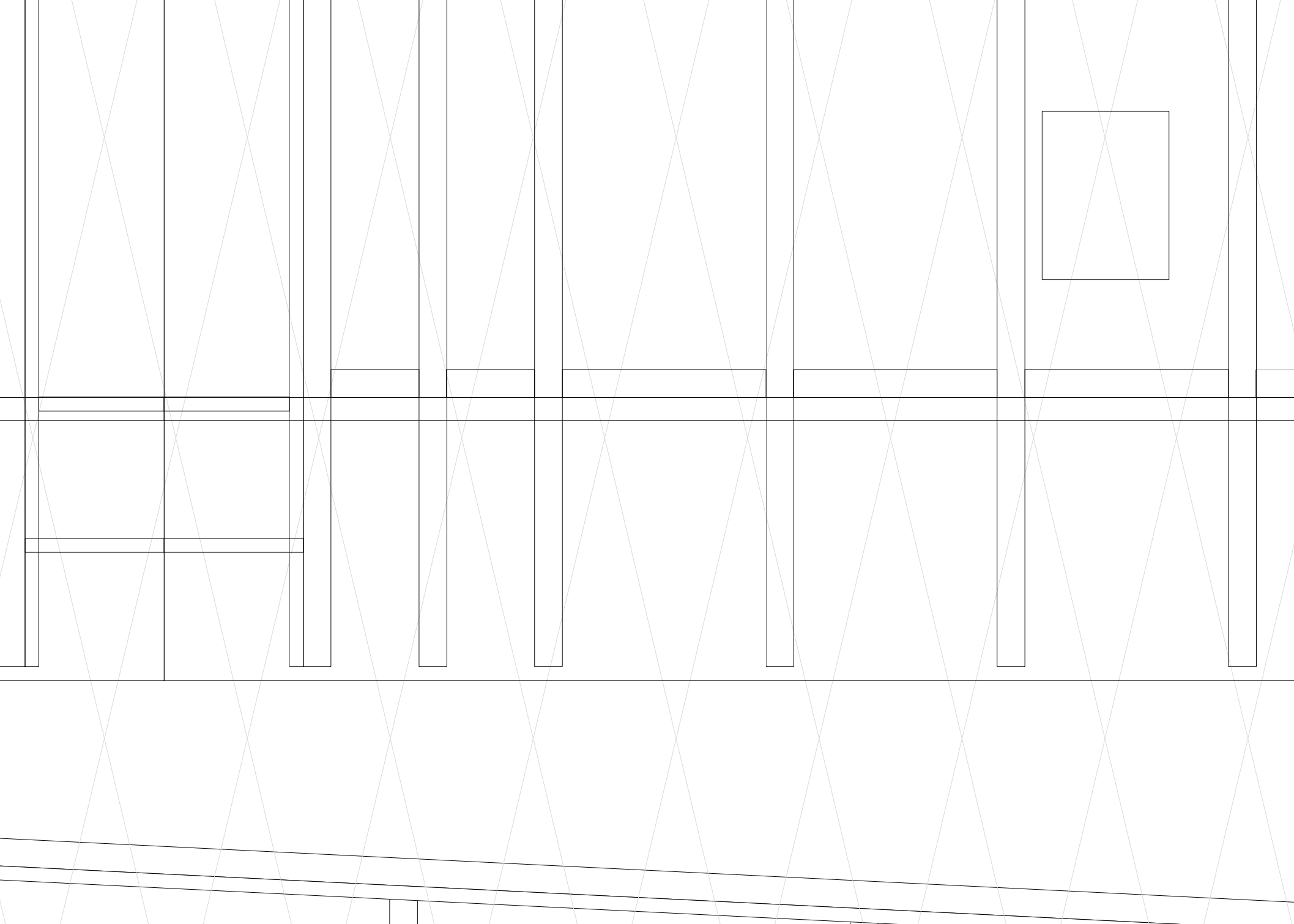

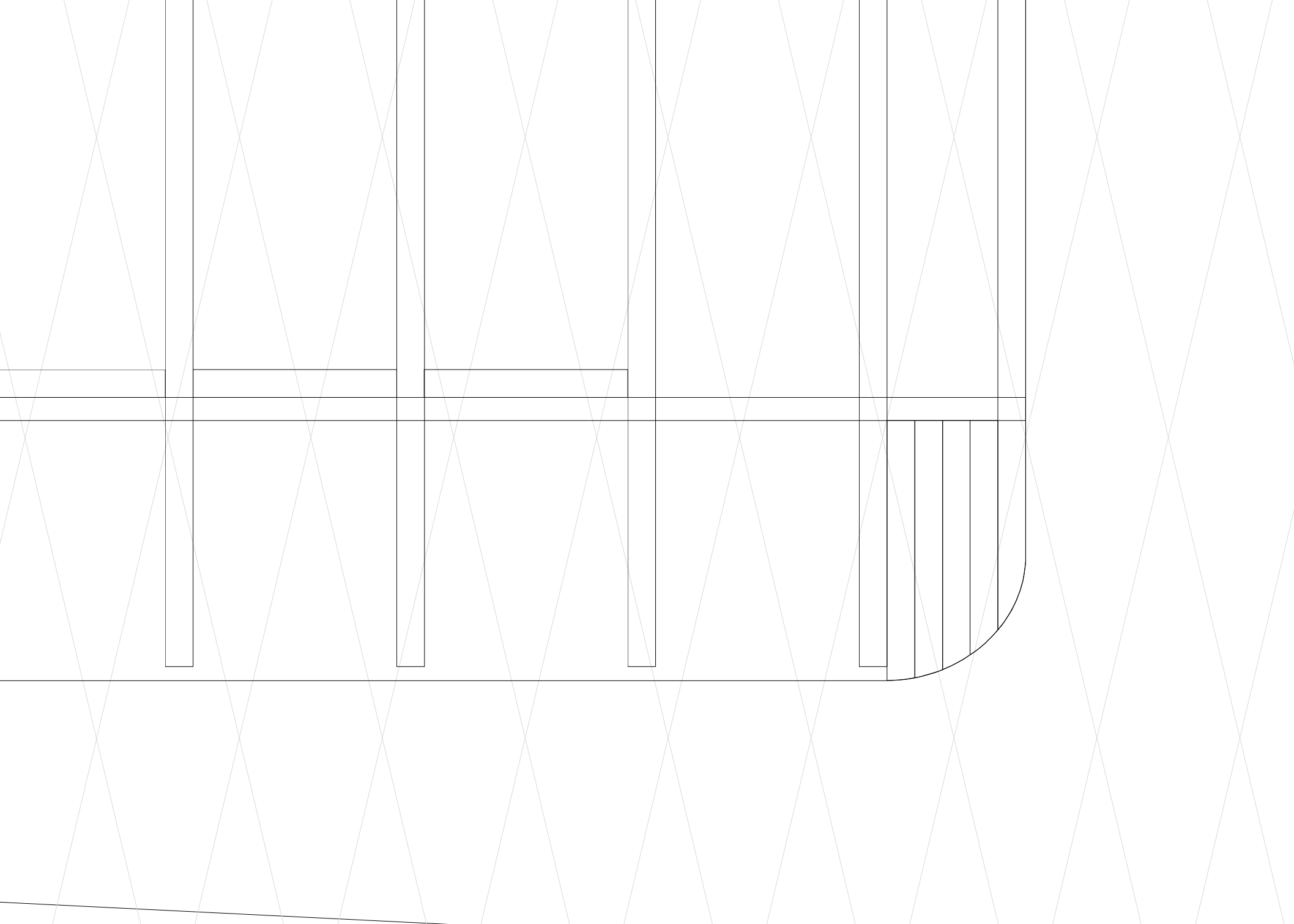

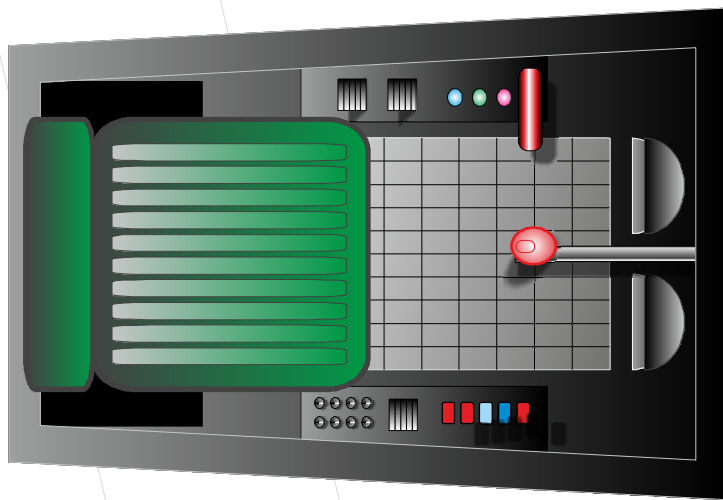

WZORZEC 100 mm - SKALA 1:1

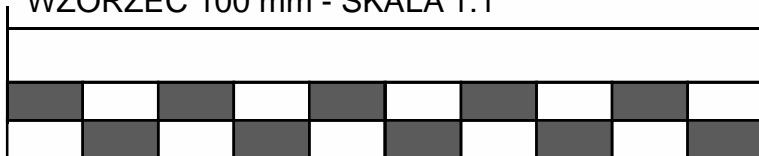

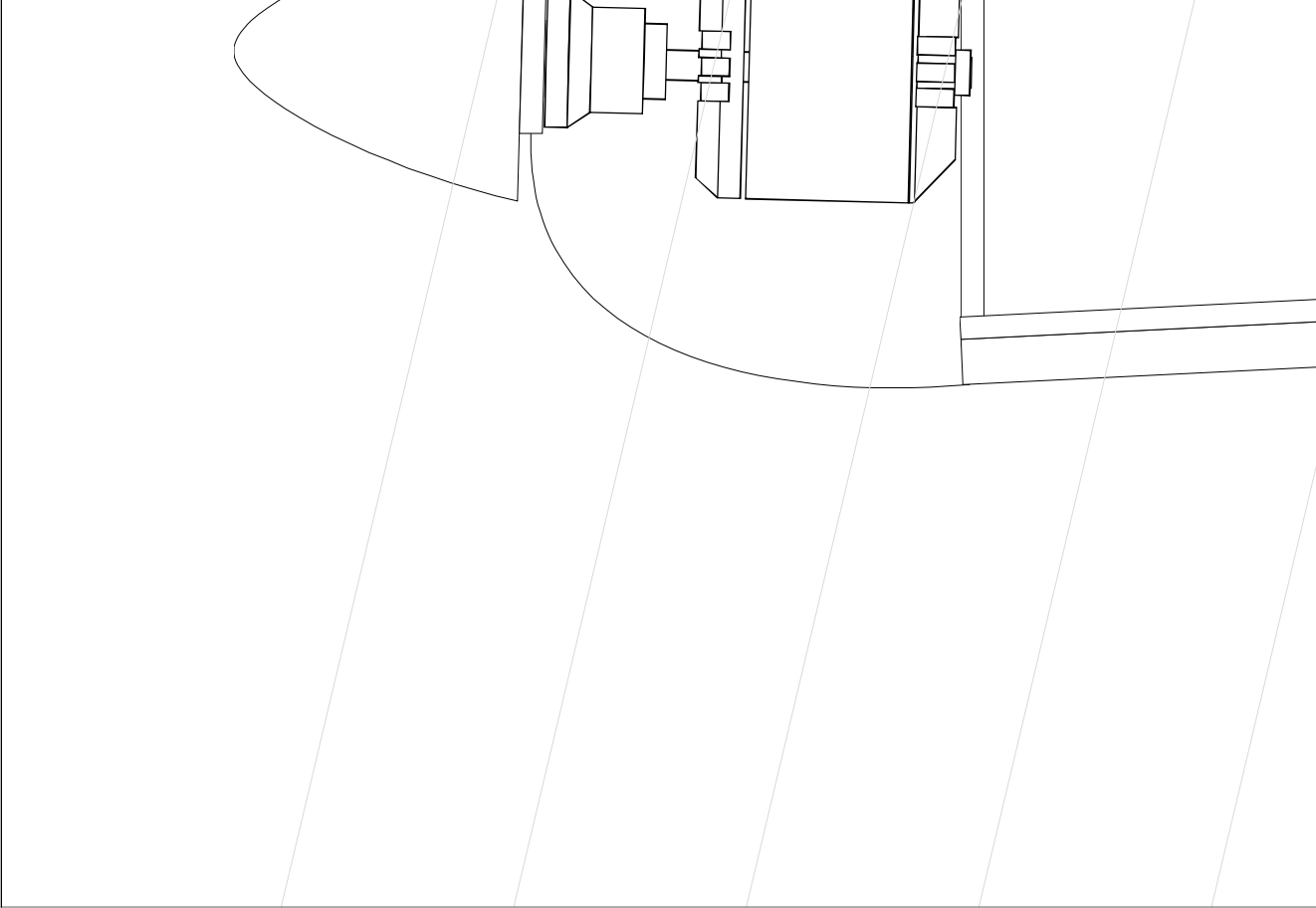





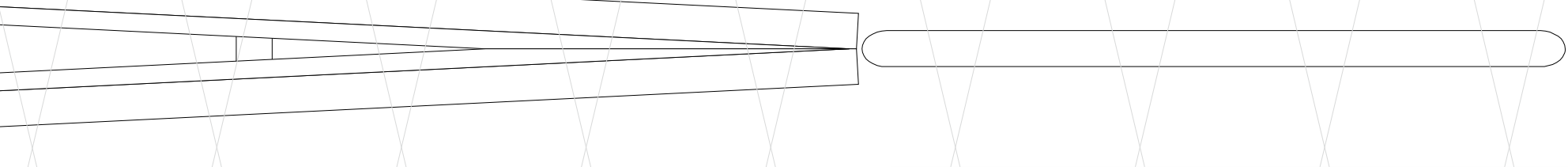

FUNFLY RC TOTO - 11 ELEM

Konstrukcja, opracowanie, kreślenie
Tomasz B. Motyl "Motylasty" - Tarnobrzeg
www.motylasty.pl
email : tomaszbm@gmail.com

Prezentowana konstrukcja jest własnością intelektualną autora, w
Wszelkie inne użycie tych materiałów poza budową n

MENTY SKŁADOWE MODELU

skie Góry 2009

Wzrost wykorzystywanie rysunków i informacji w celach komercyjnych jest ściśle zakazane.
Modelu dla własnych celów wymaga uprzedniej pisemnej zgody autora.