

Bok kadłuba - prawy

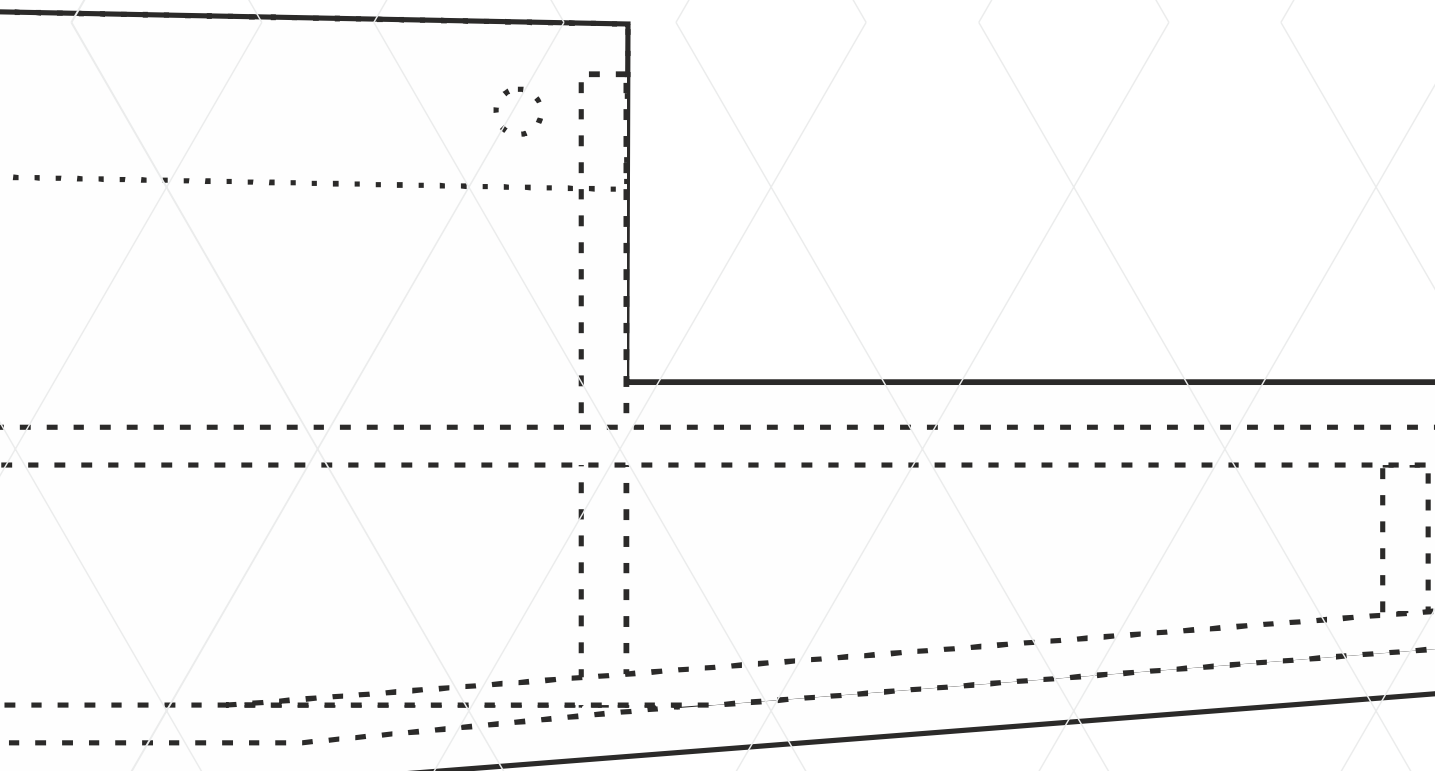

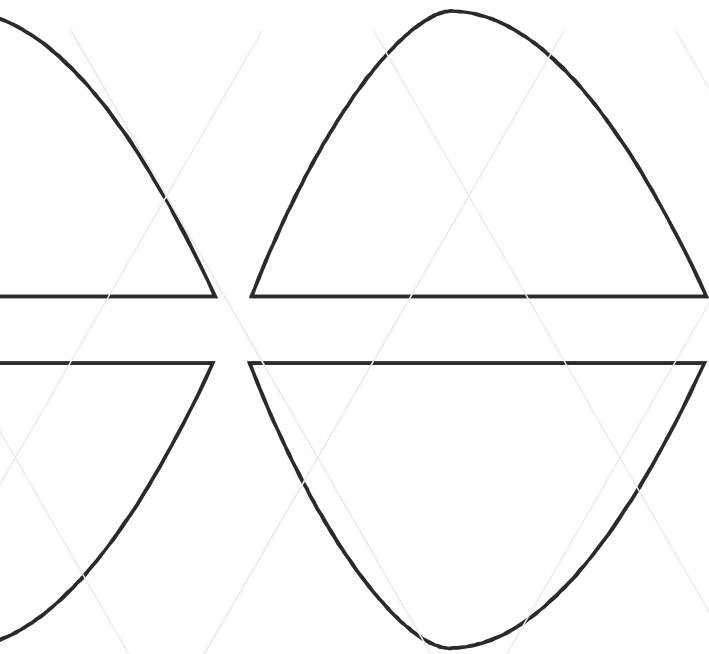

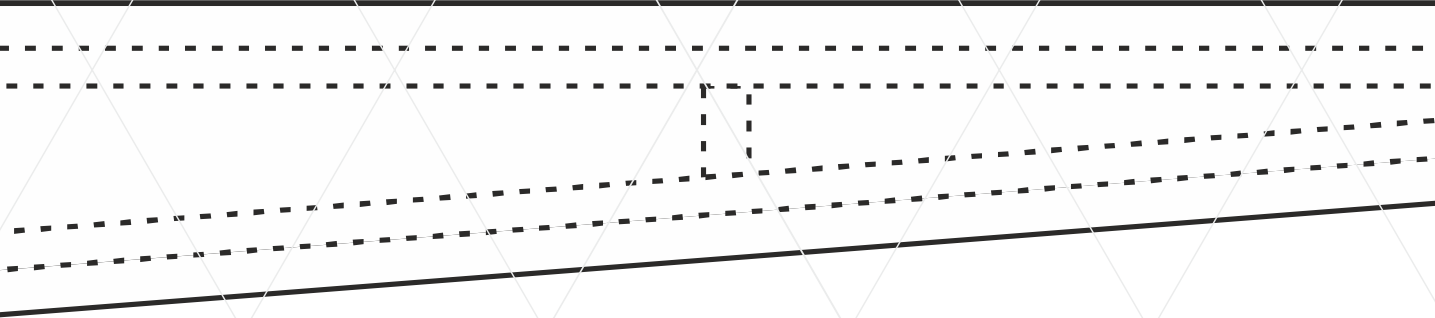
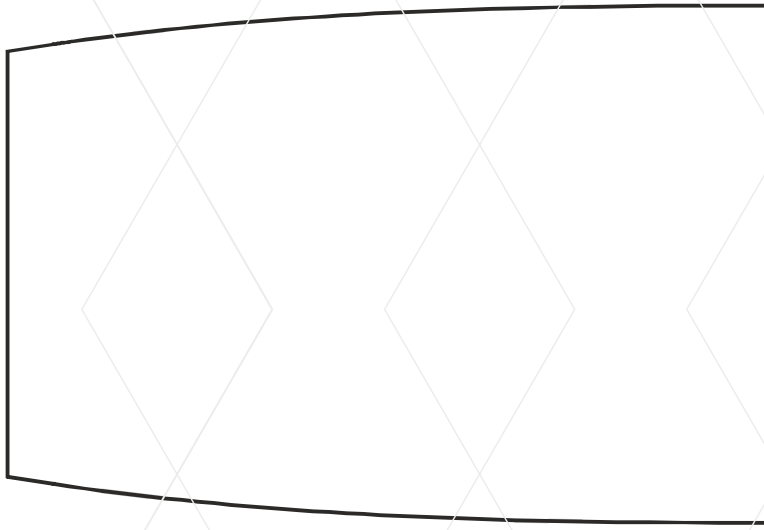
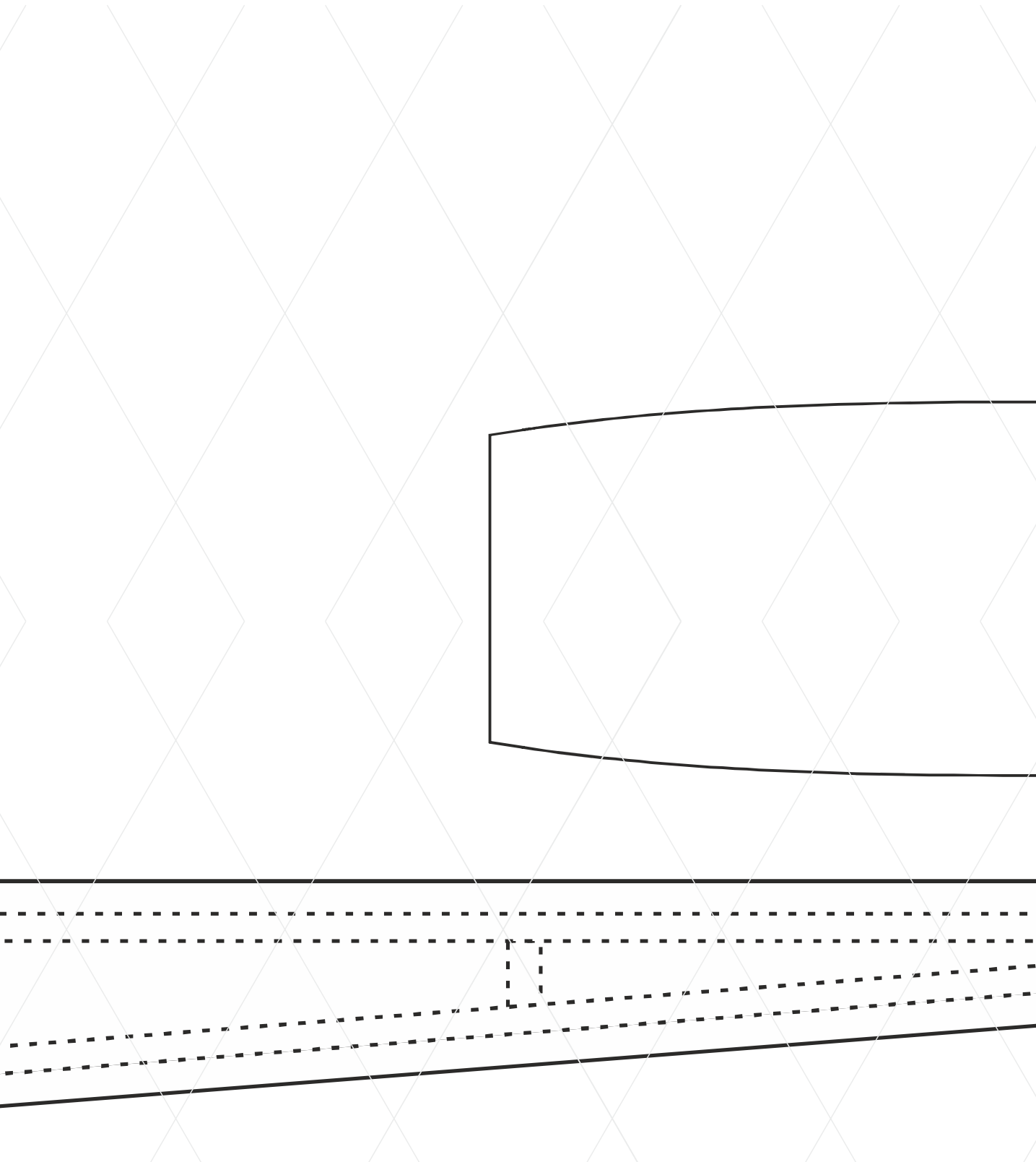
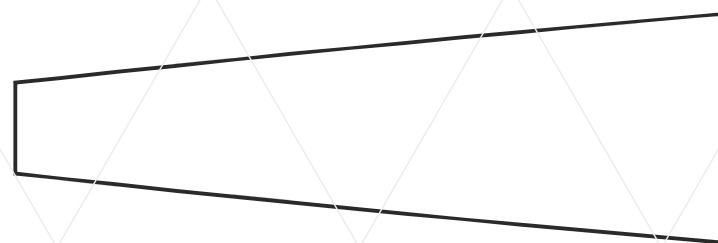

Spód kadłuba

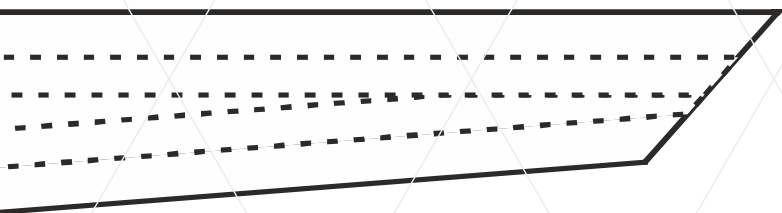



Góra kadłuba - część tylna

Góra kađtub



ba - część przednia

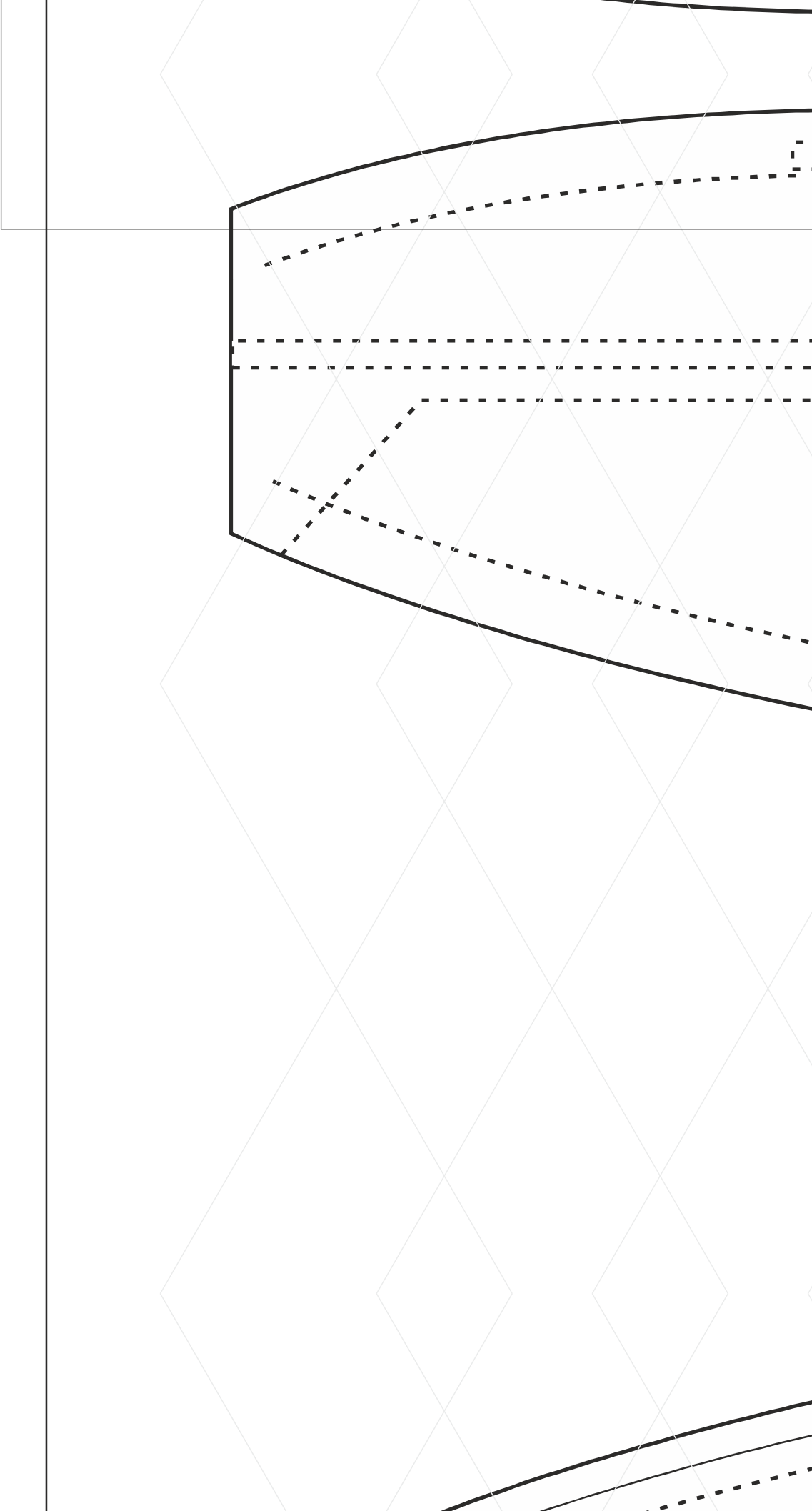

Bok kadłuba - lewy

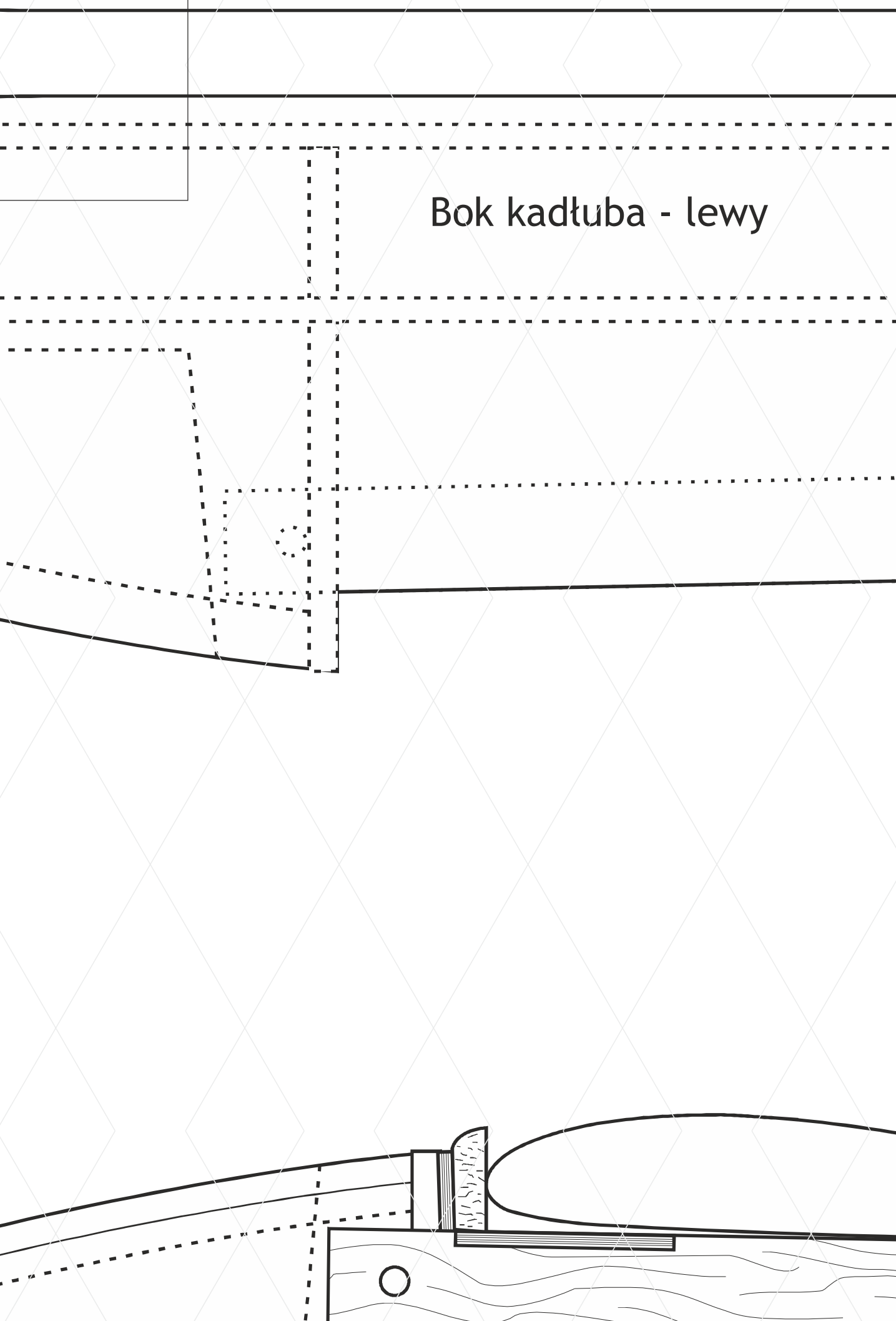

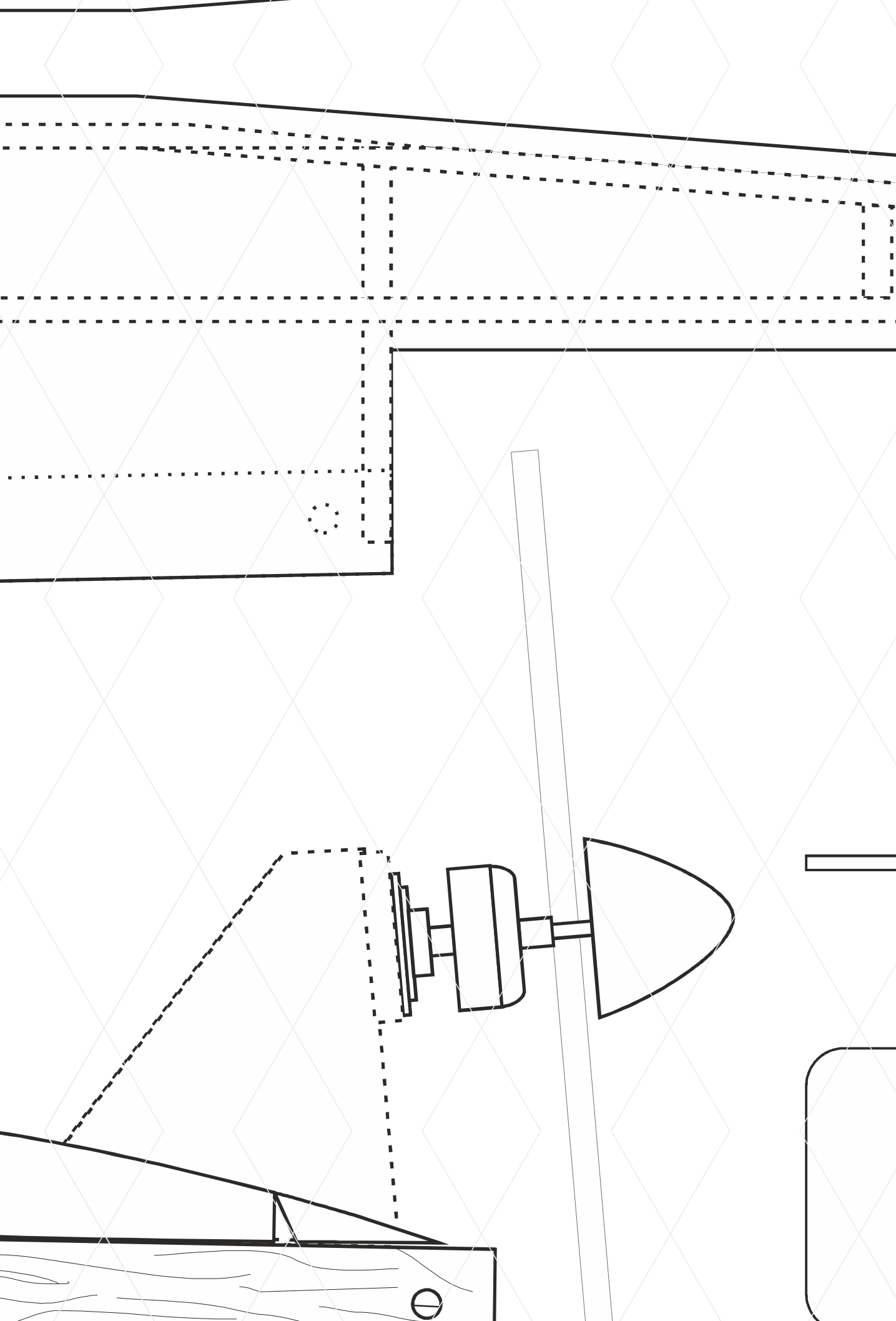

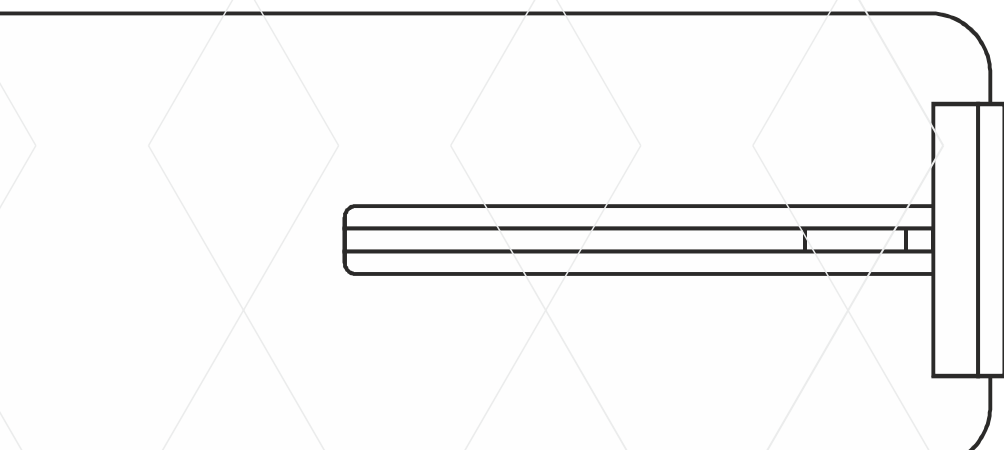
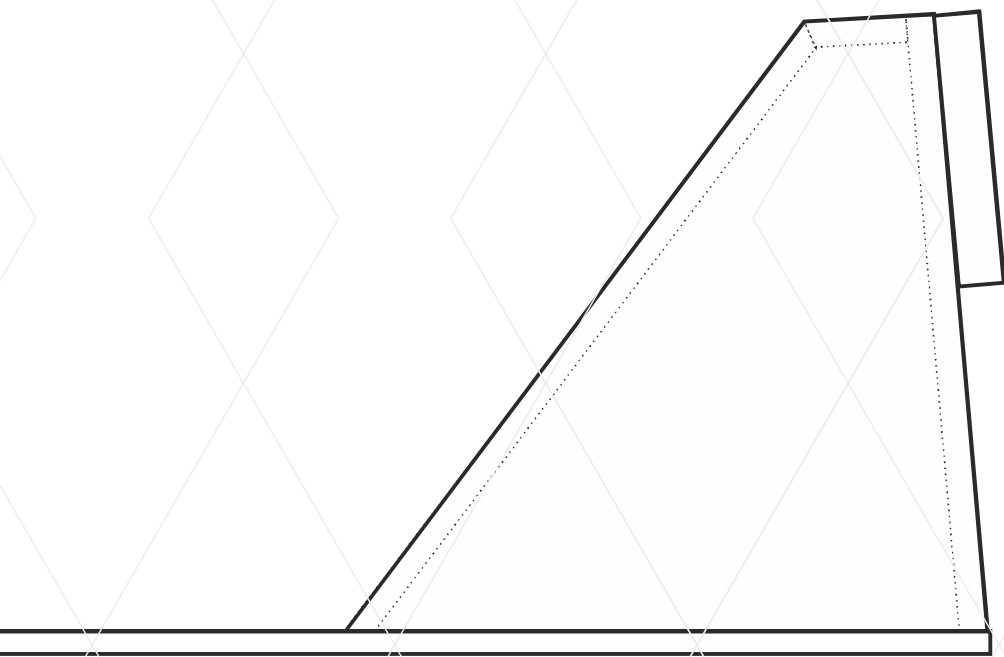
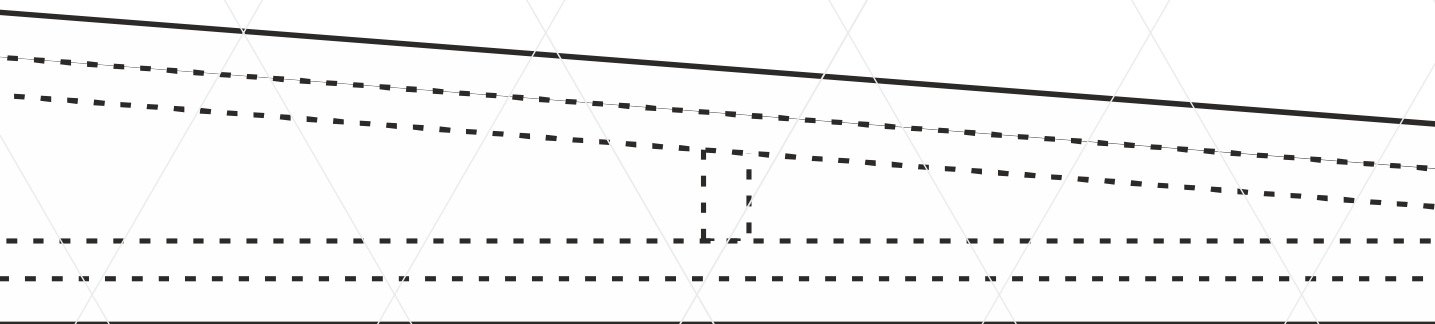

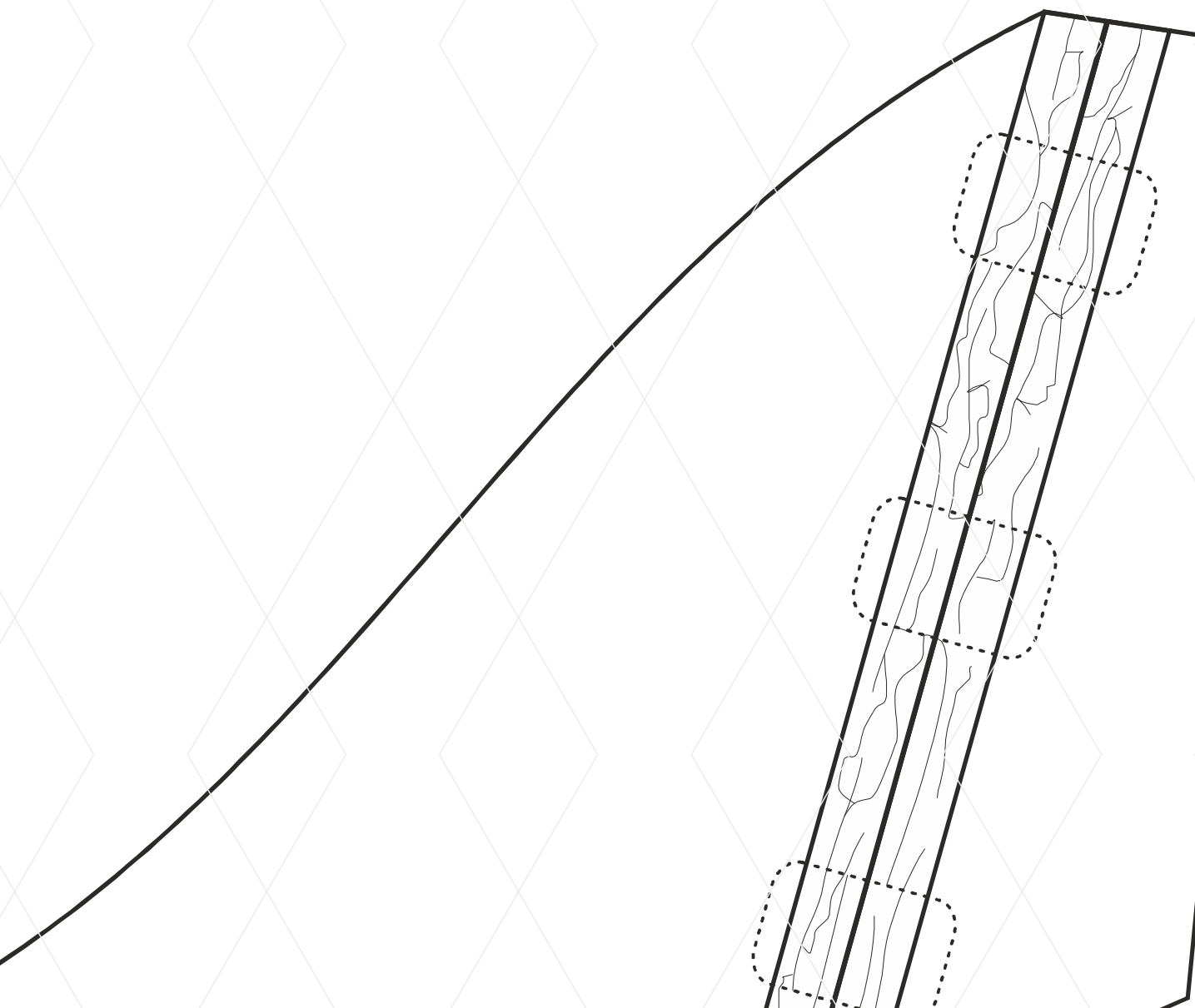
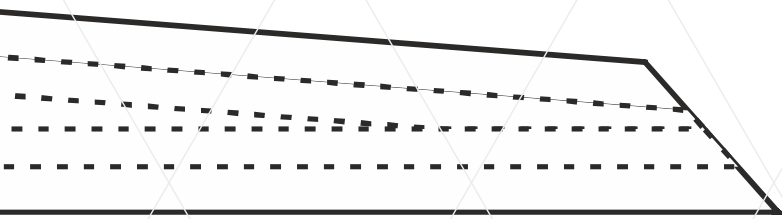

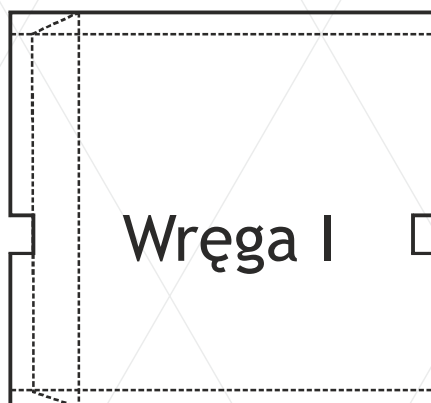
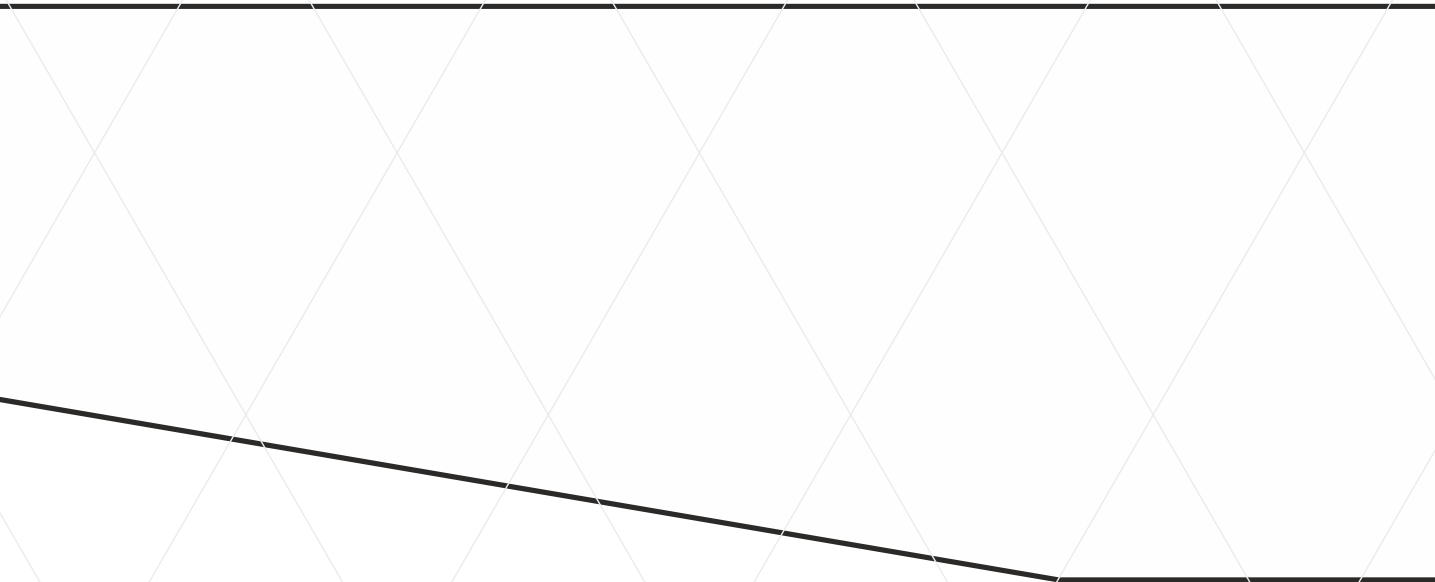
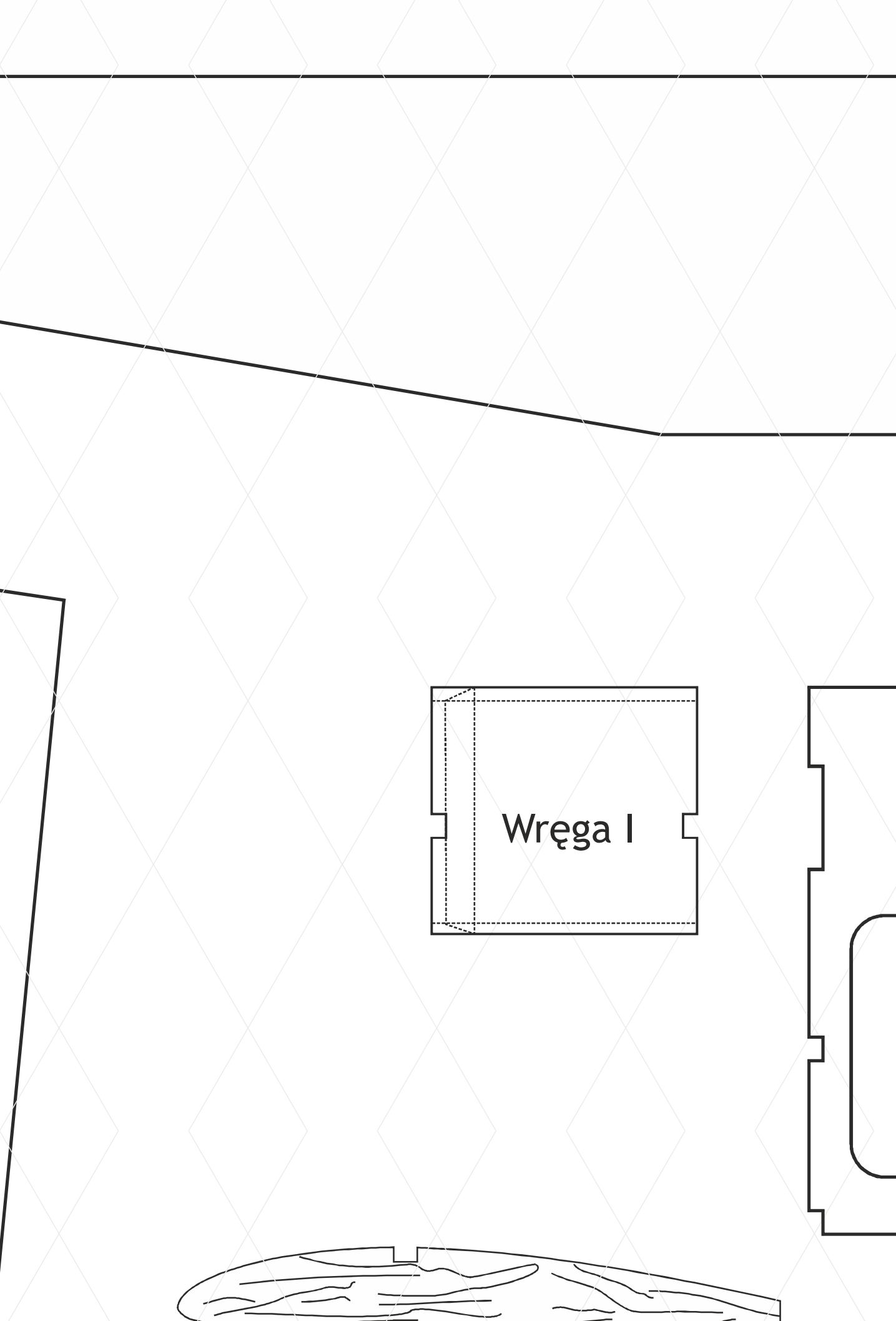

Wręga I



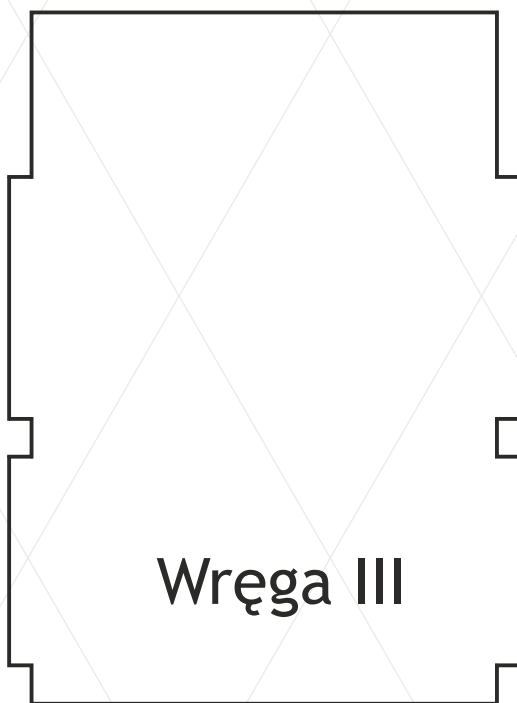
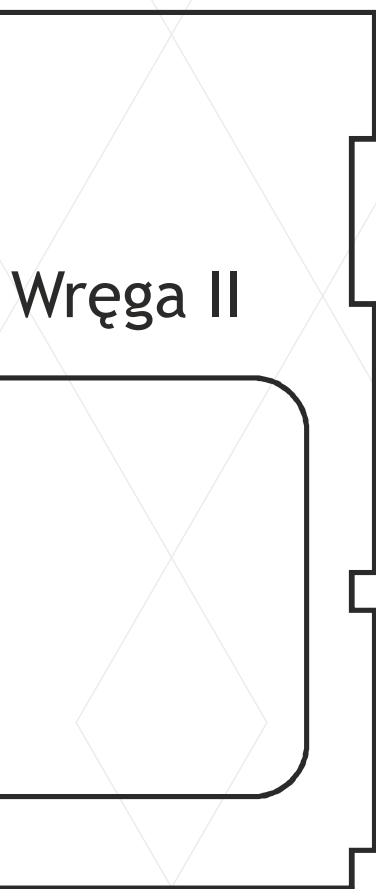

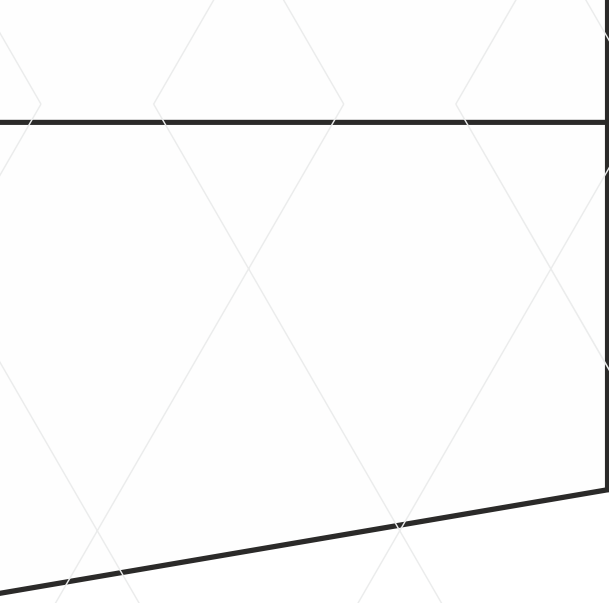

Wręga V

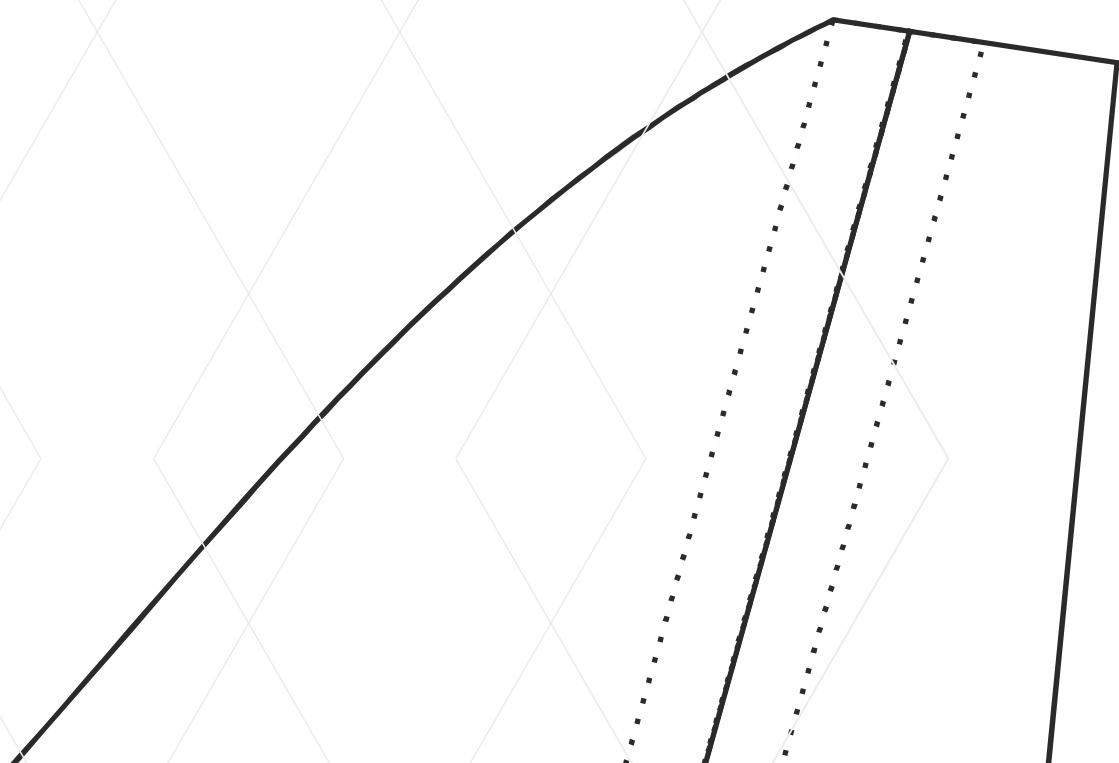

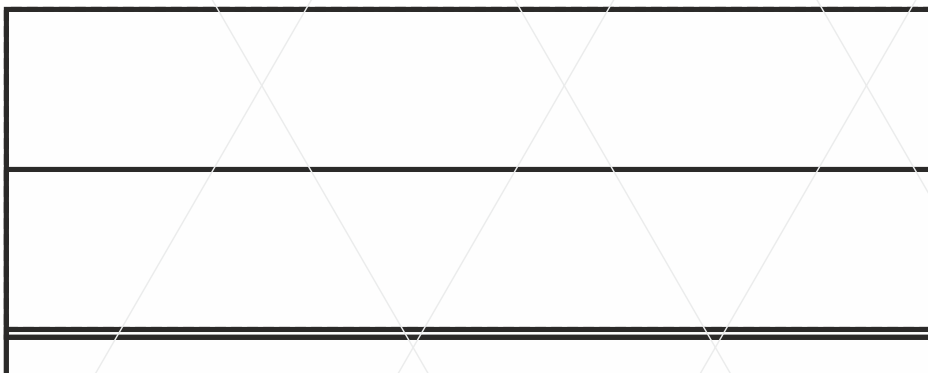
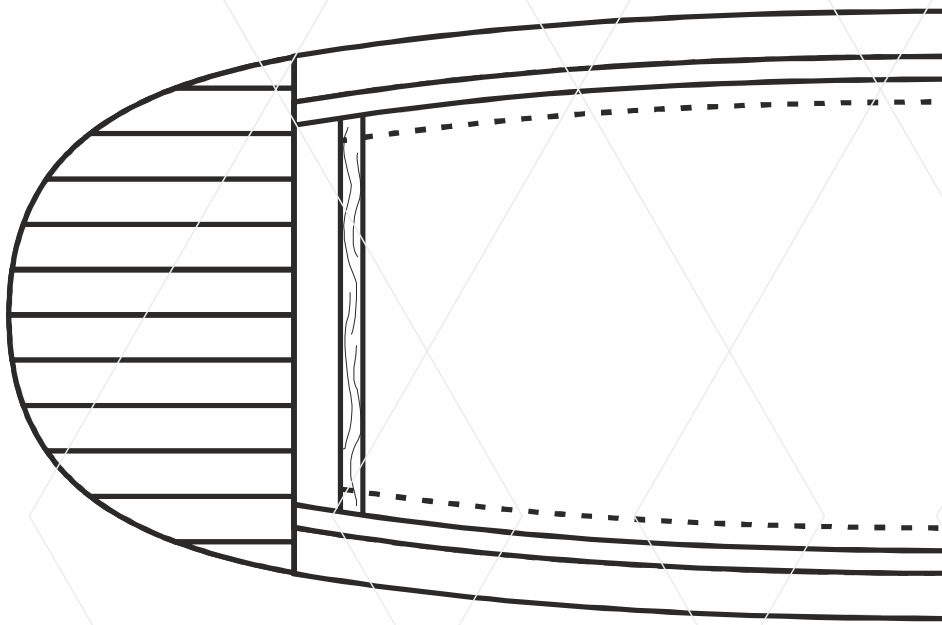
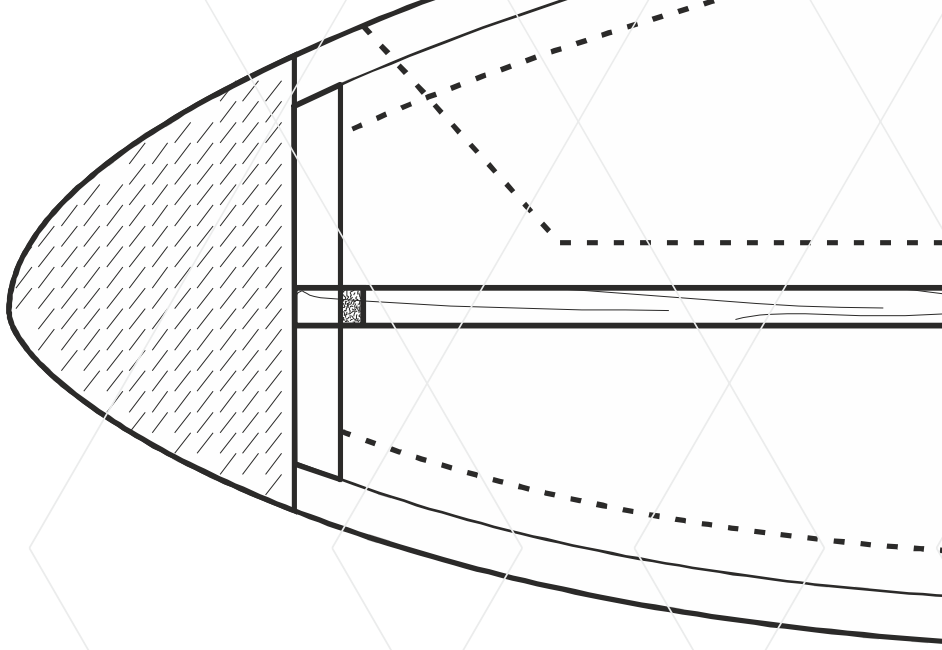

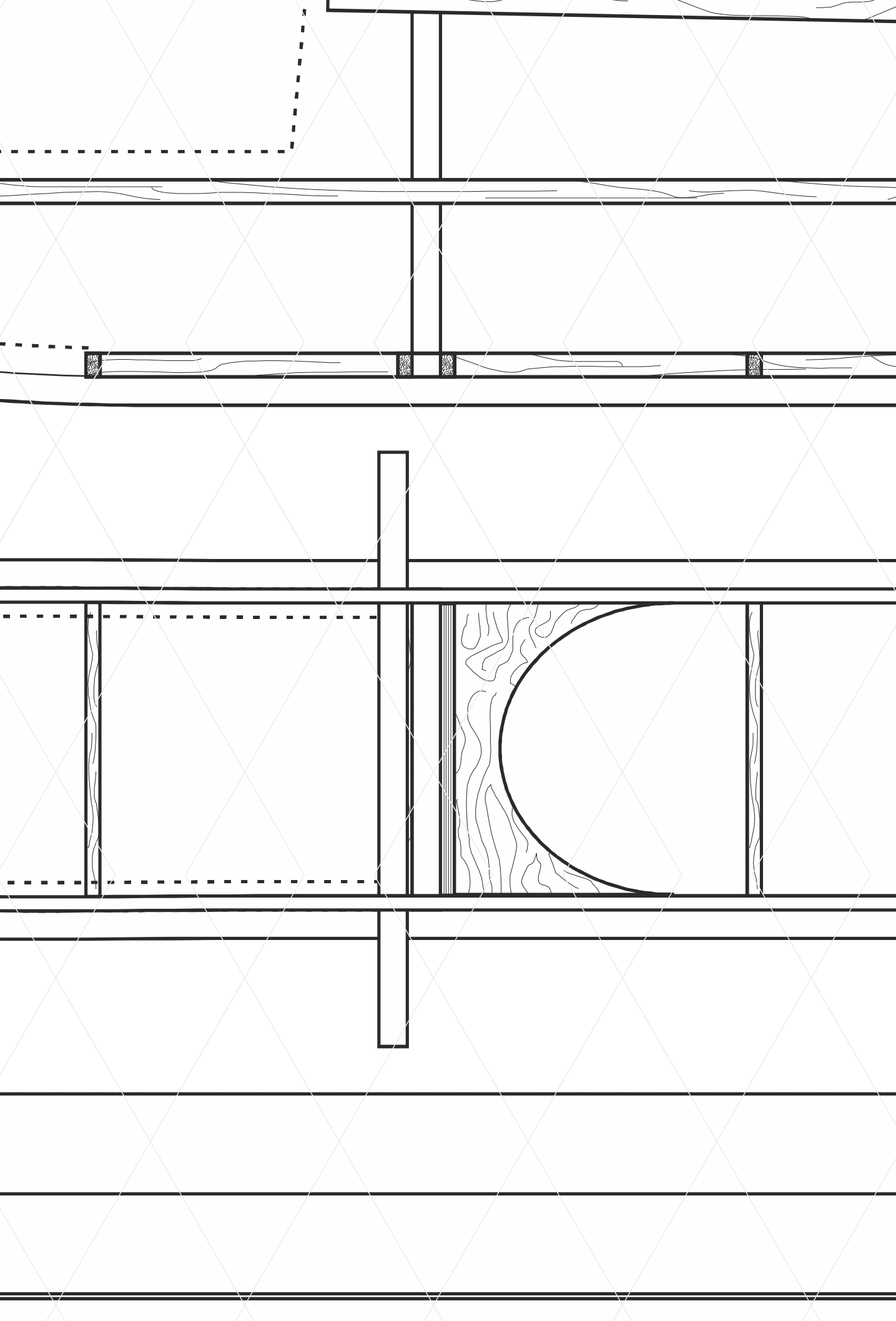

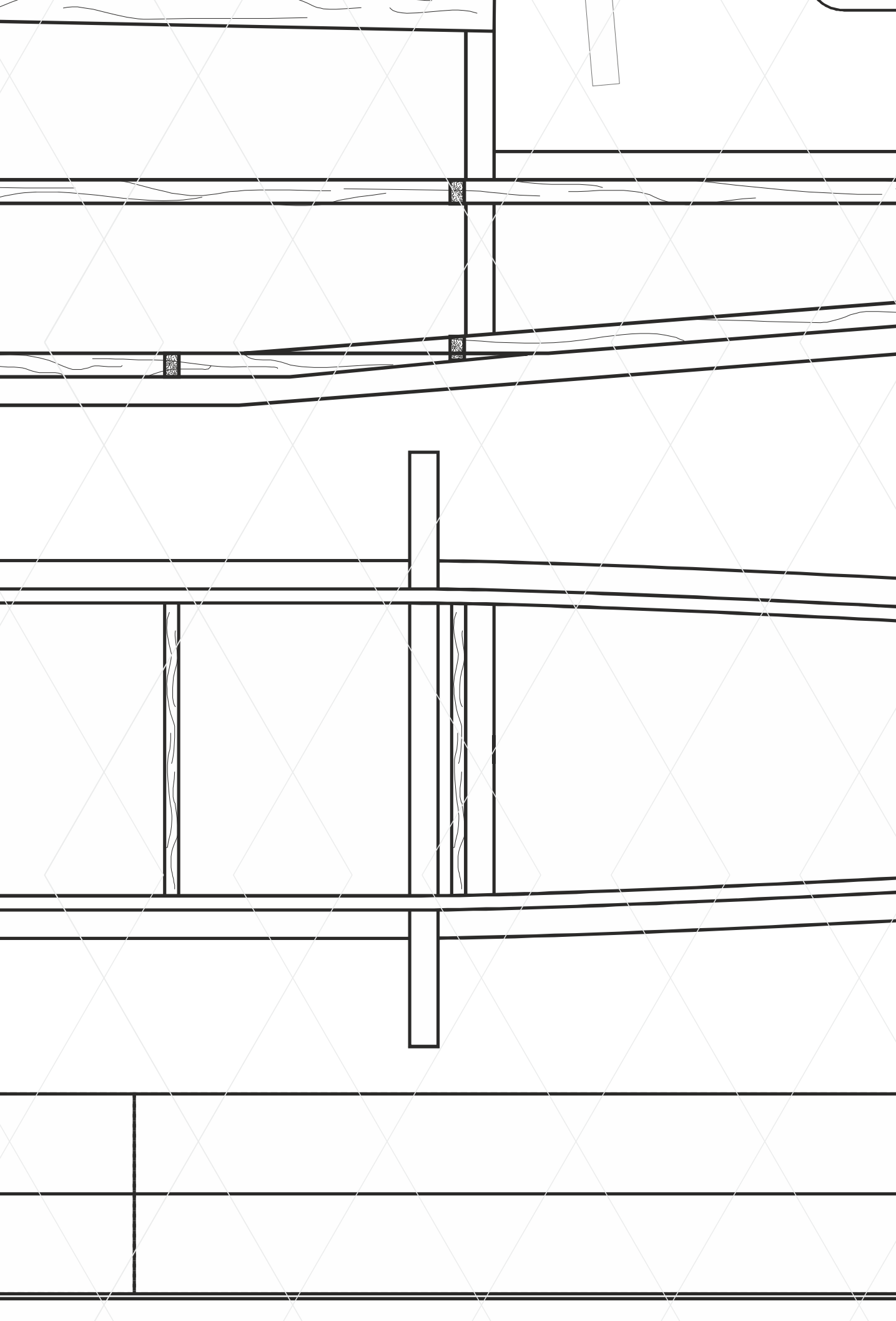

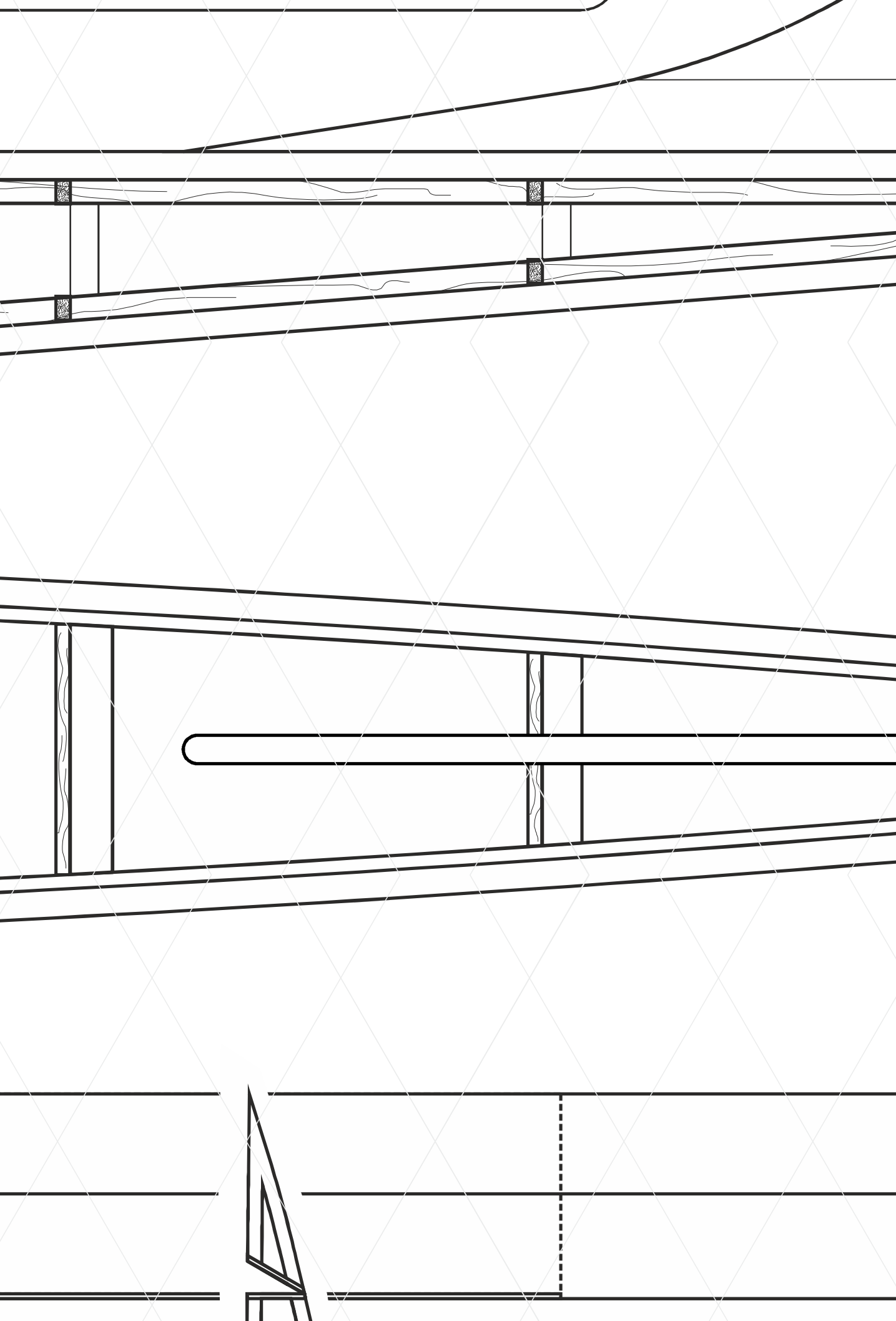

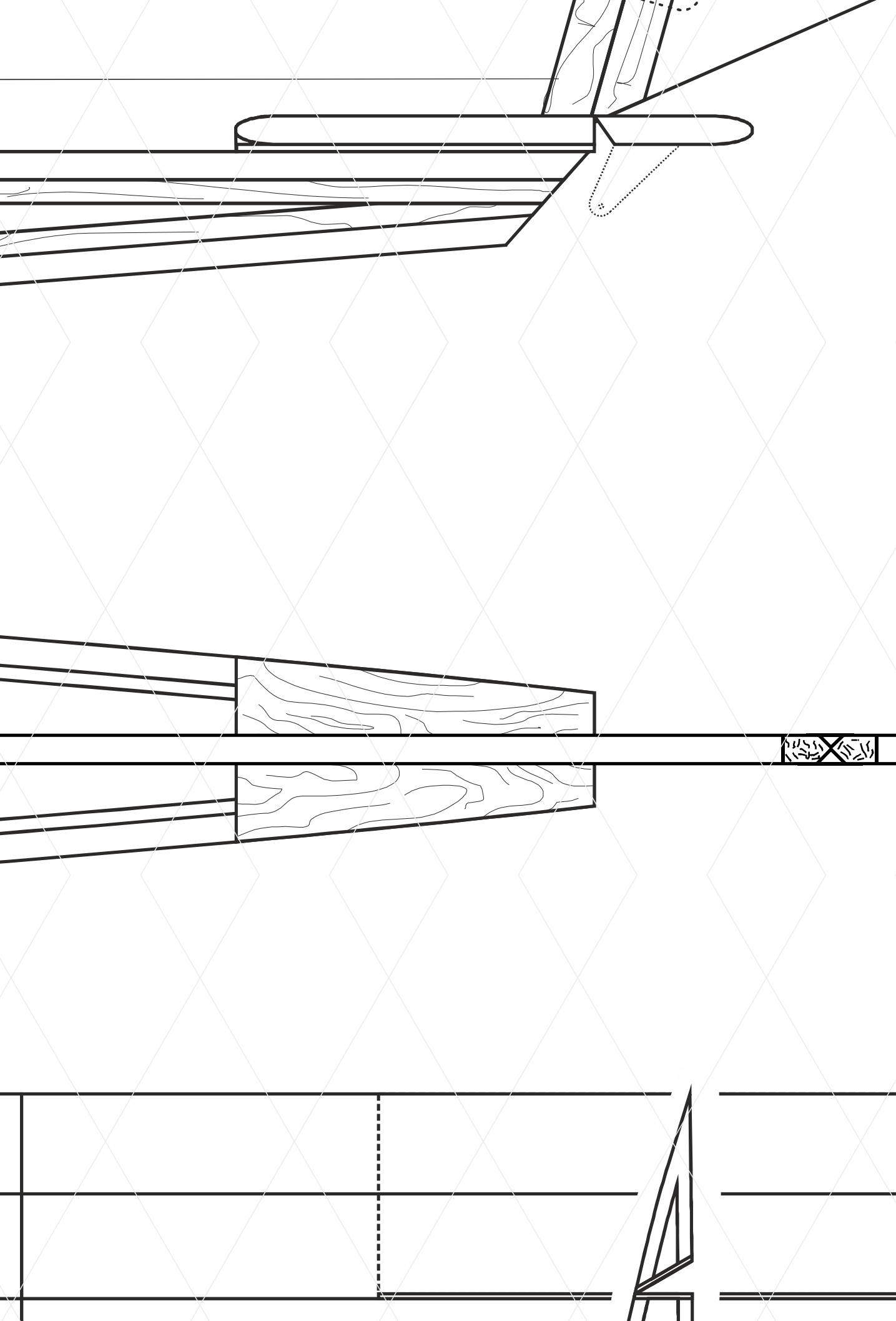

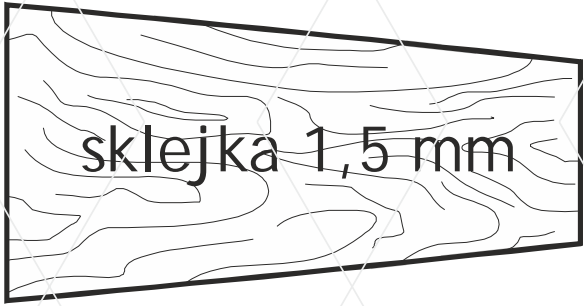

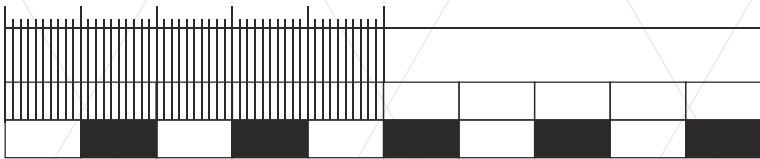
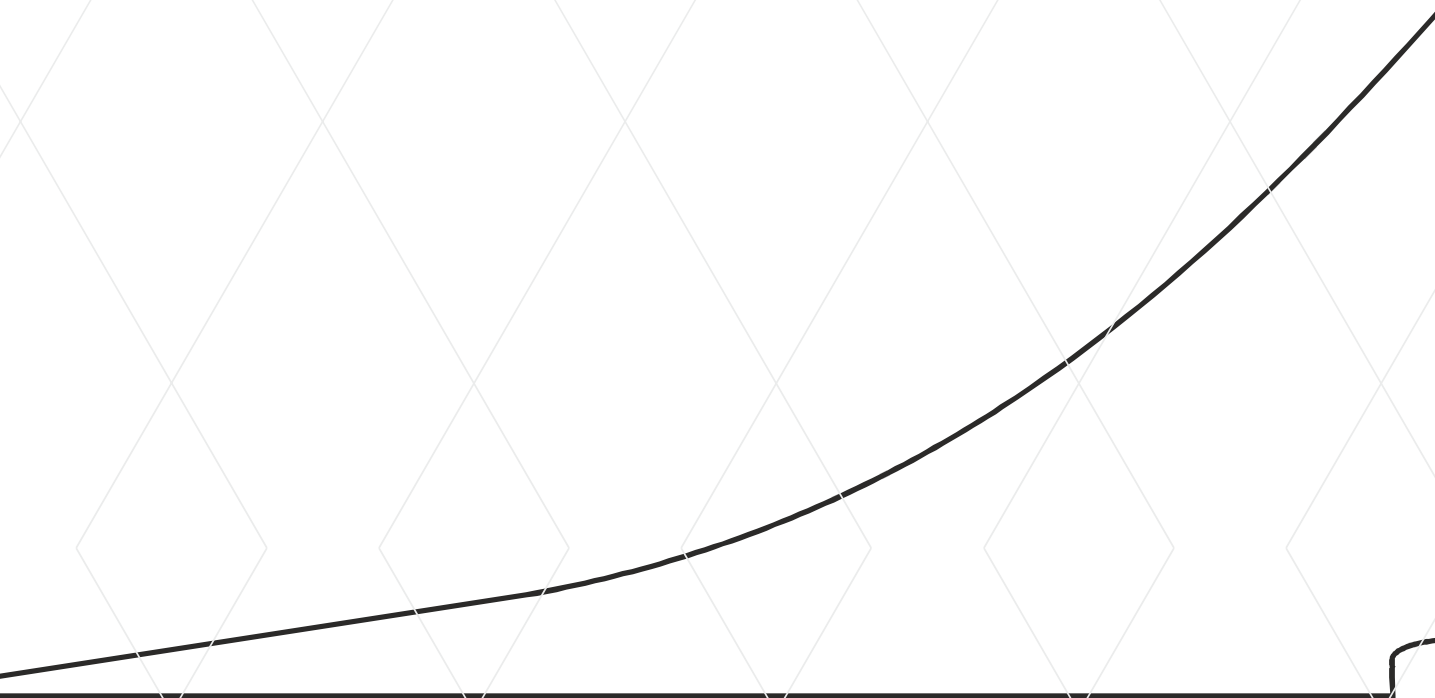

WZORZEC 100 mm - SKALA 1:1

TOTO-3 FP

Konstrukcja, opracowanie, kreślenie
Publikacja planów : maj 2013
Strona : <http://www.motylasty.pl>

Prezentowana konstrukcja jest wyłącznie do celów informacyjnych i nie należy budować modelu na własne potrzeby.

WYKRES „DOLNOPŁUK”

Opis : Tomasz B. Motyl „Motylasty” - 2011-2013

Blog : <http://motylasty.blogspot.com/>



www.motylasty.pl

Własnością intelektualną autora. Wykorzystywanie rysunków i informacji w celach innych, niż do celów artystycznych lub też i w innych celach komercyjnych bez zgody autora jest czystym świństwem.

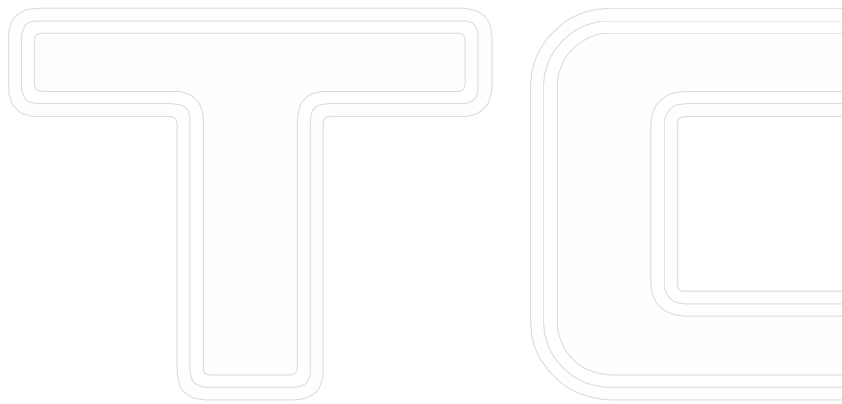
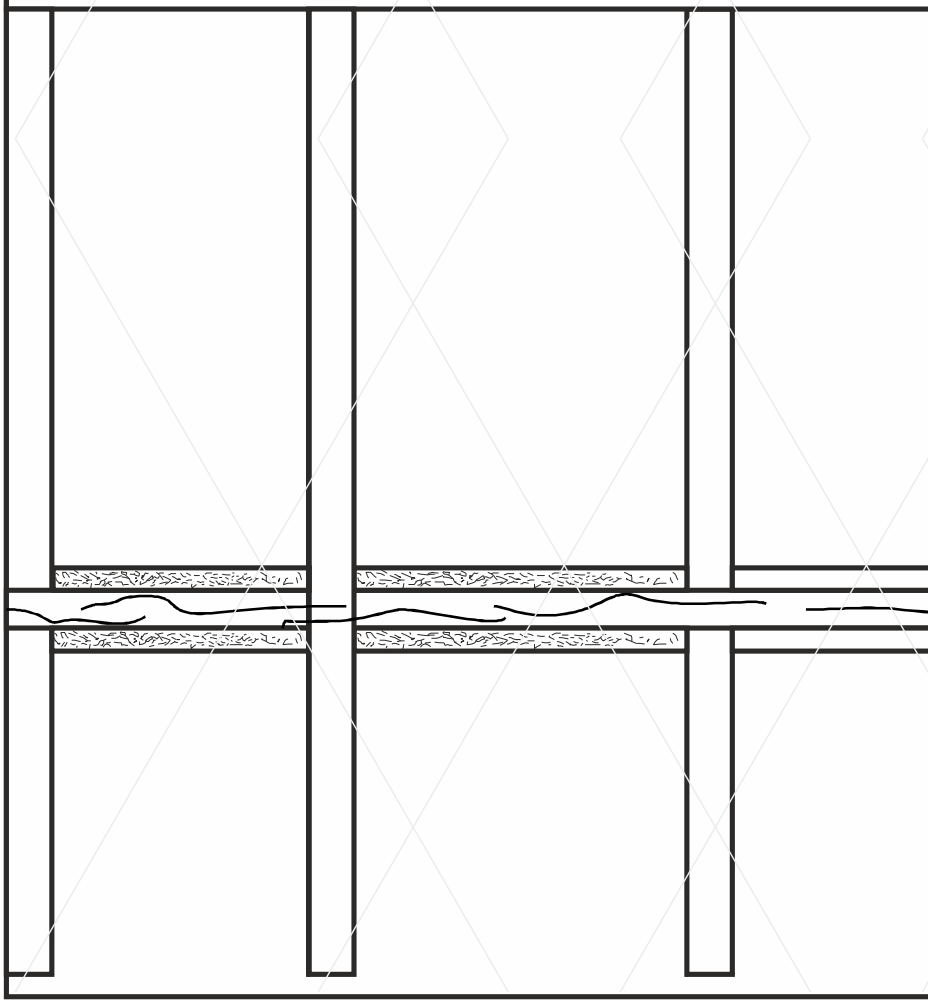

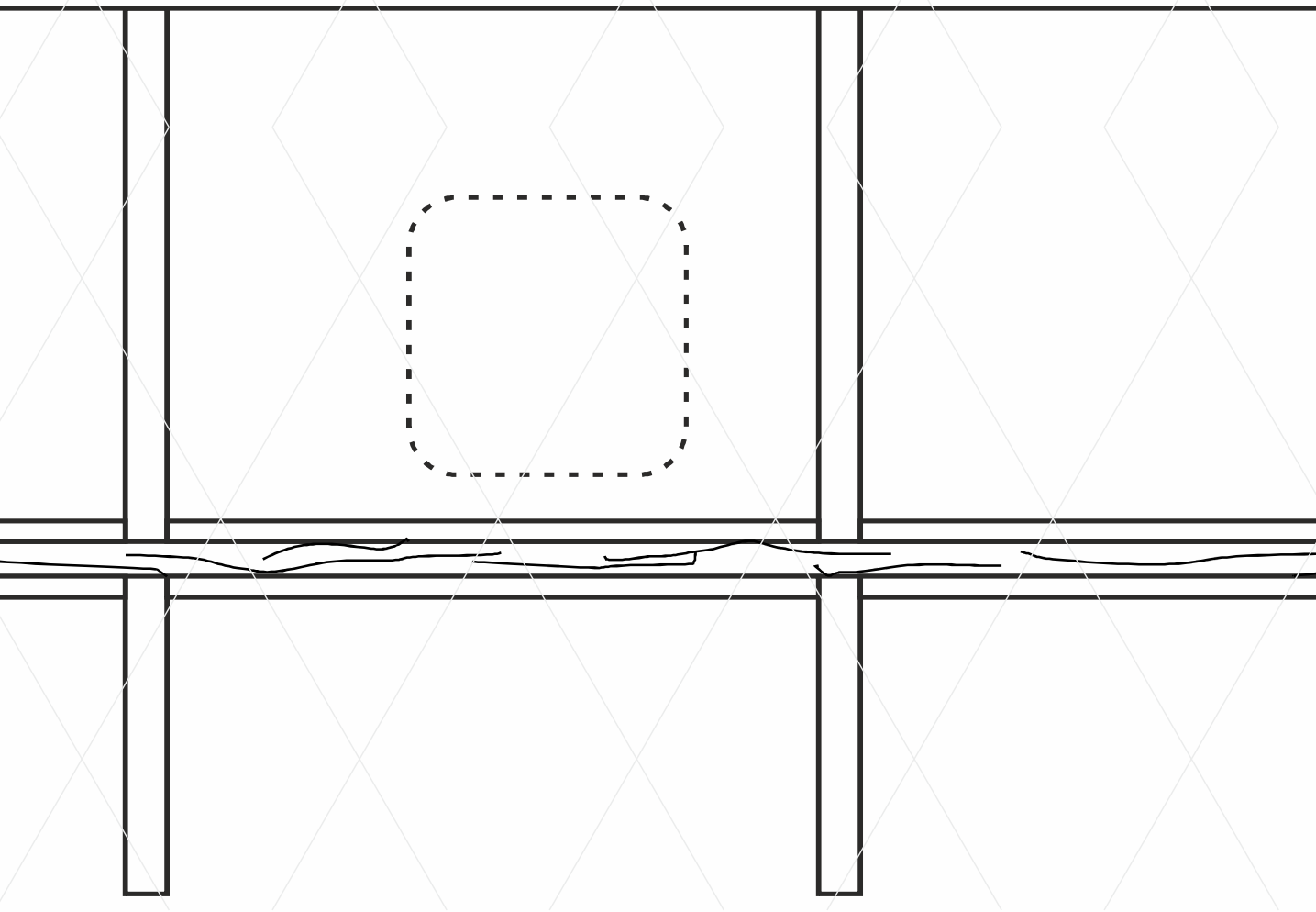

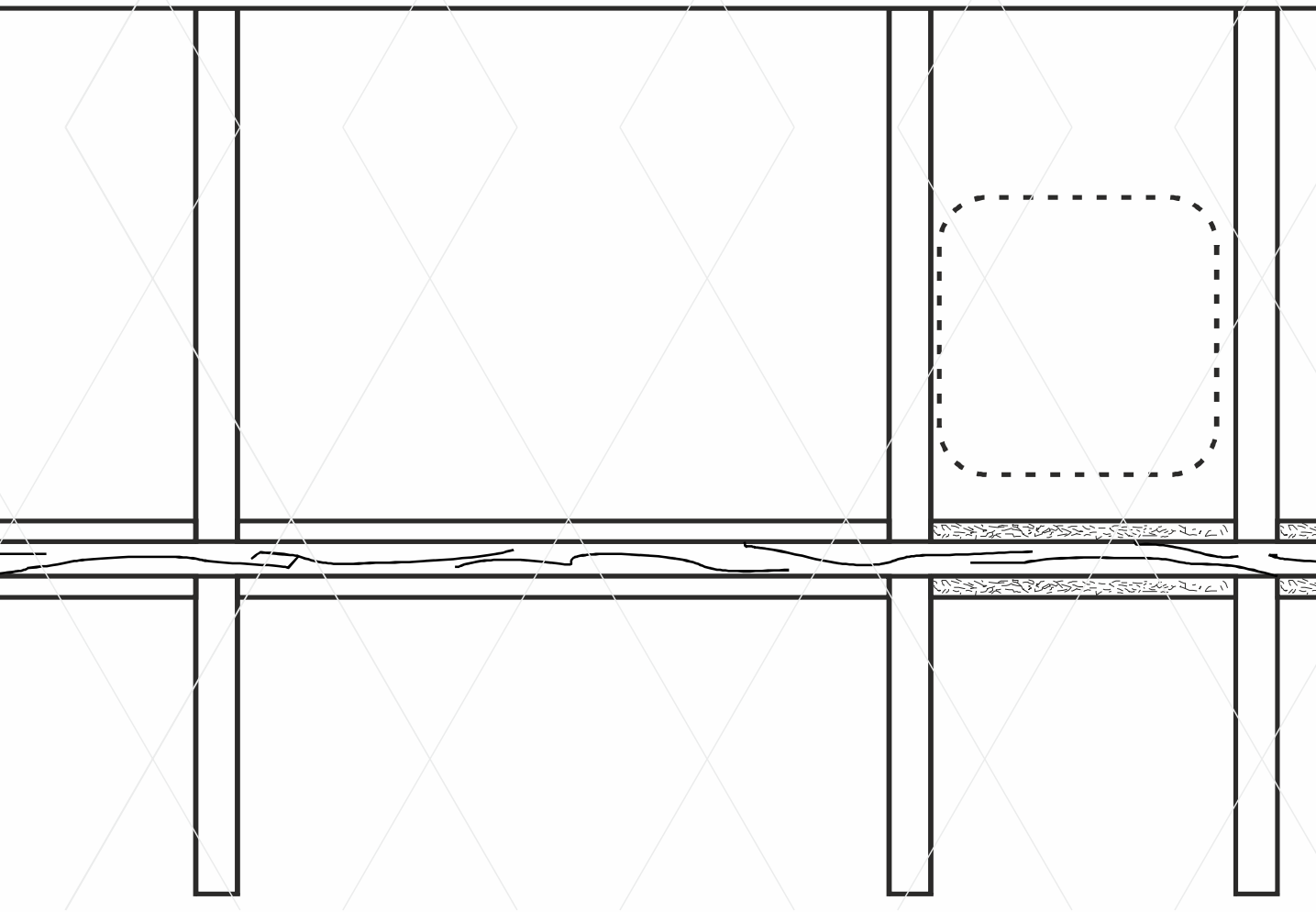

3 F

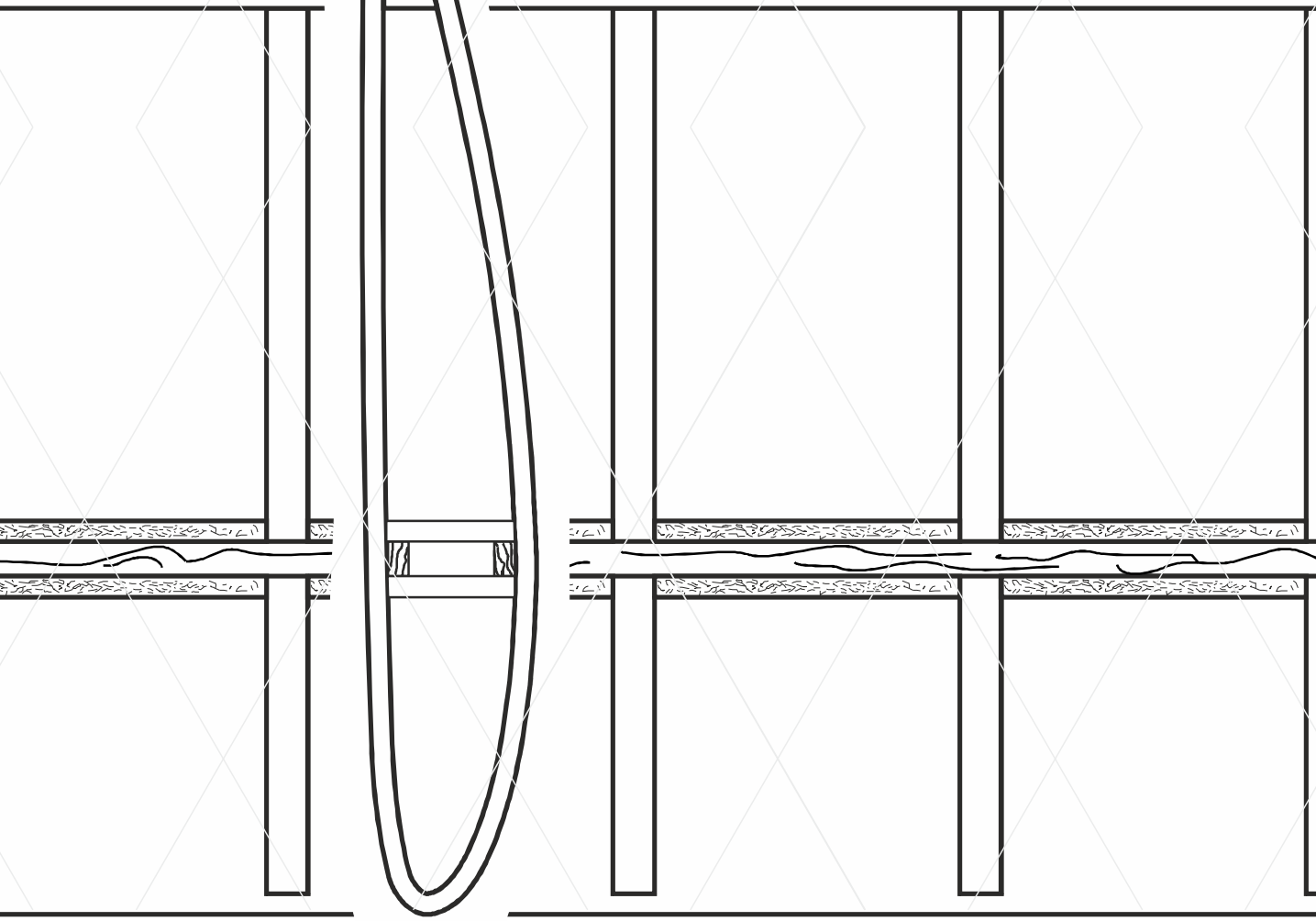

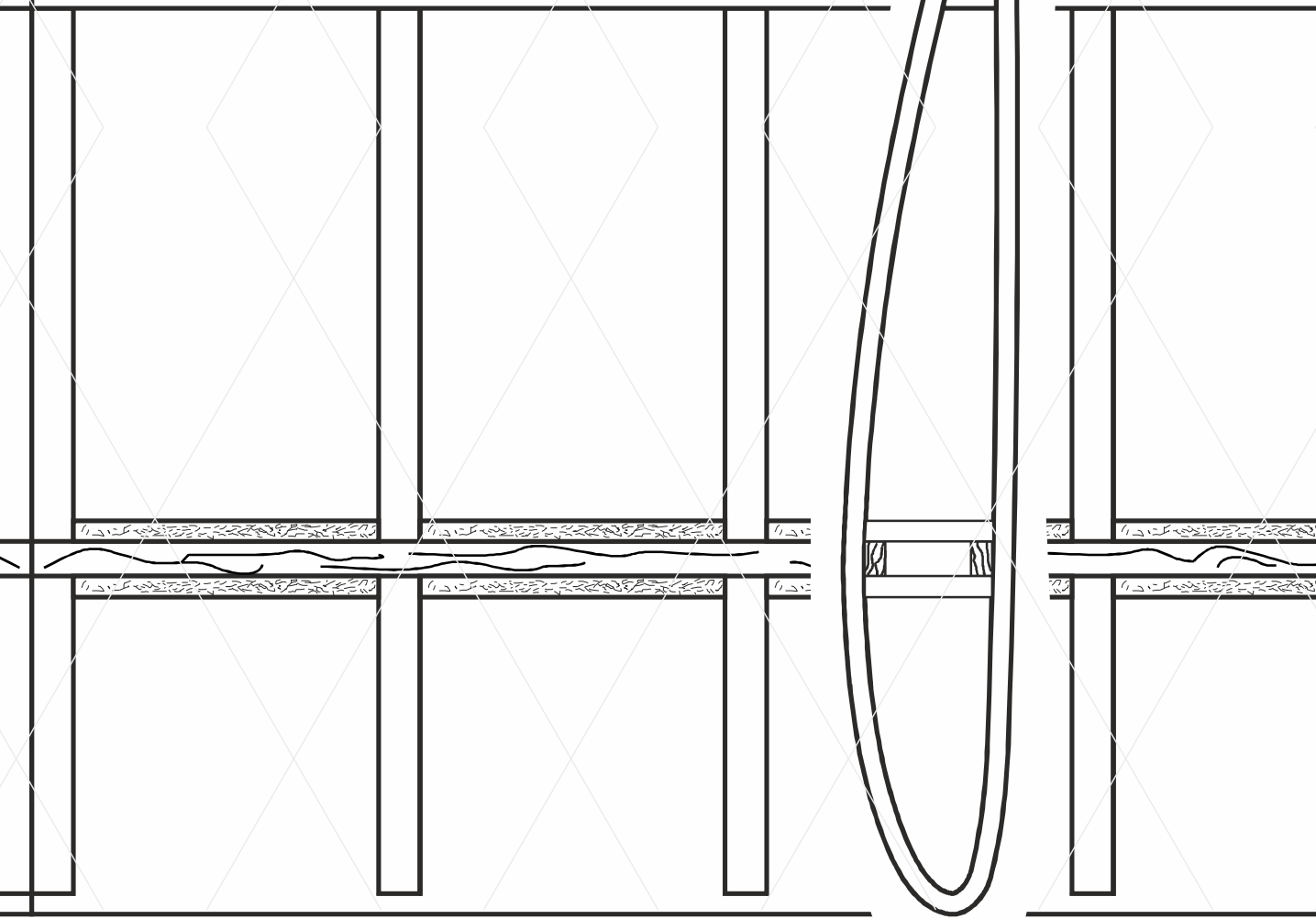

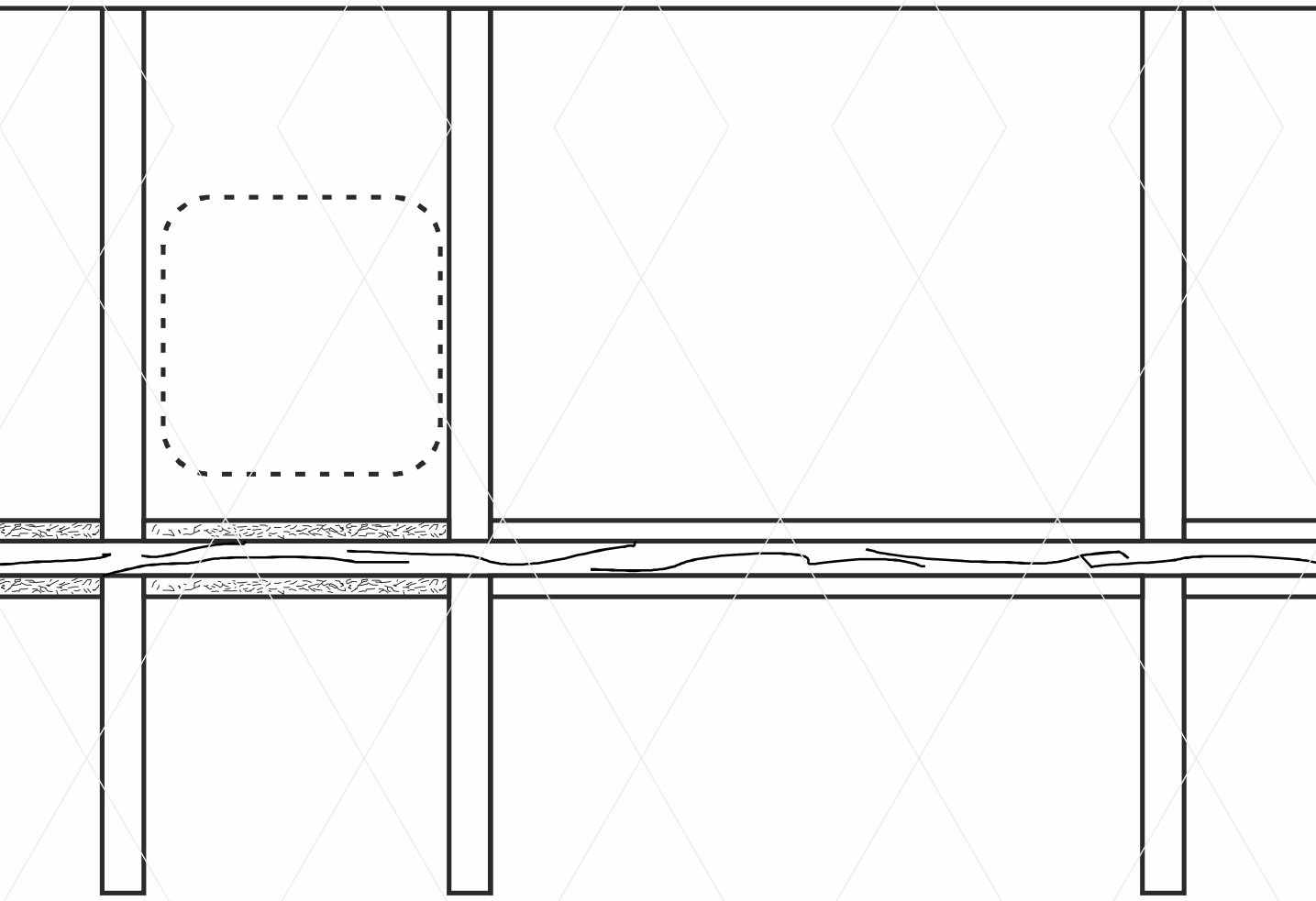

L N O

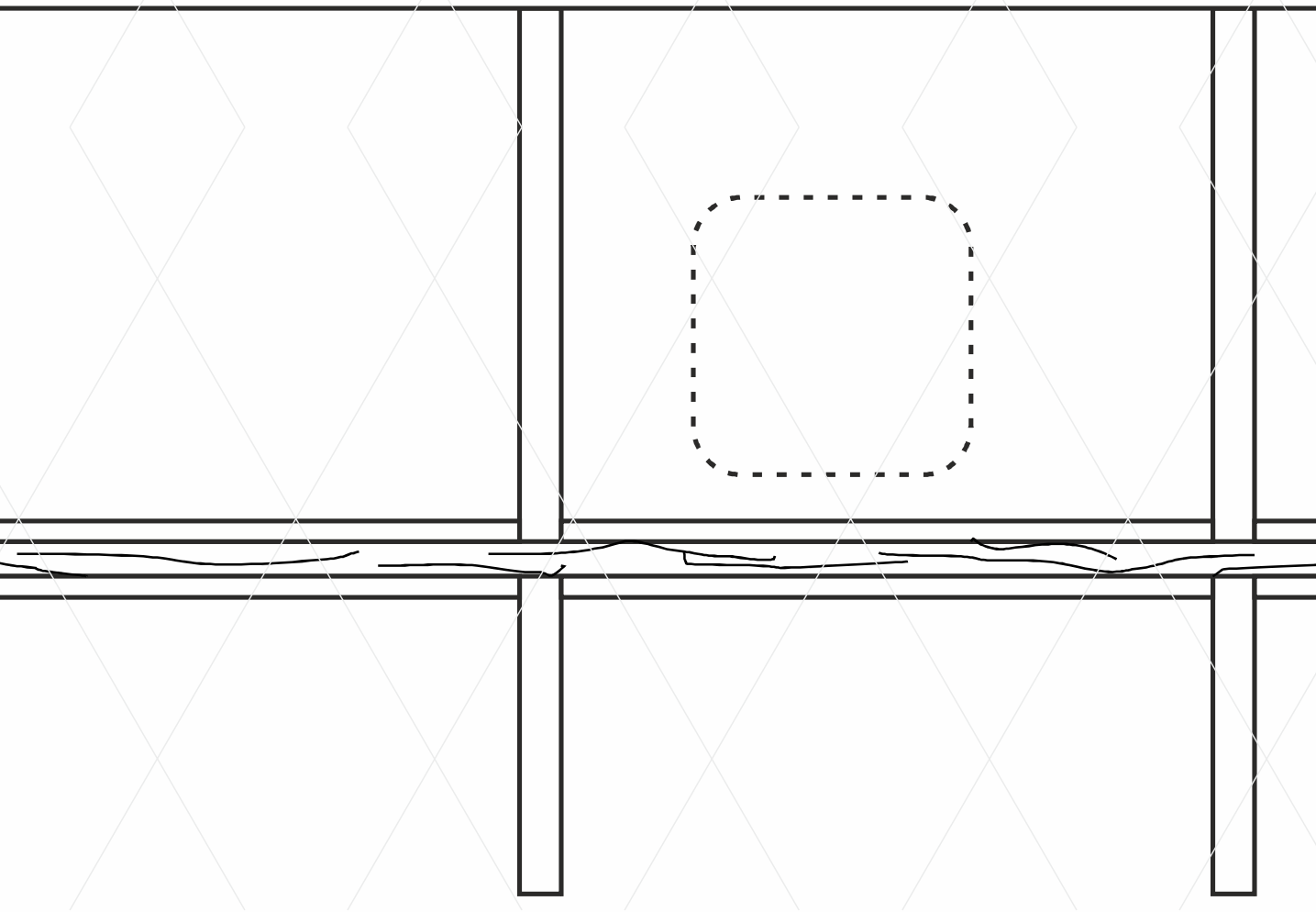

APPLE

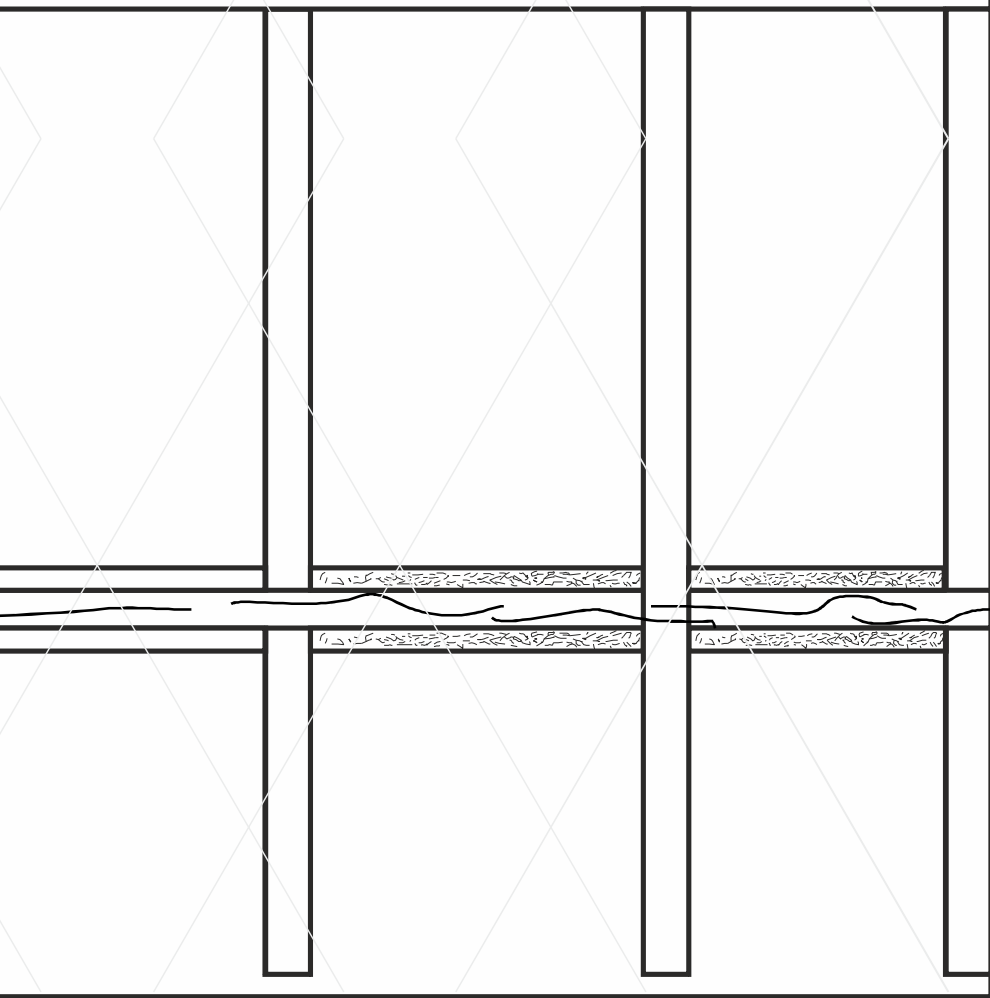

JKK